

## **ADDENDUM NUMBER 1**

To the Contract Documents  
For the Construction of

### ***SMITH TECH ACADEMY PLAYGROUND UPGRADE PROJECT***

*for*

***COLTON JOINT UNIFIED SCHOOL DISTRICT  
Bid No. 24-18FAC***

February 7, 2024

## **NOTICE TO BIDDERS**

*It is intended that all work affected by the following provisions shall conform to the original plans and specifications. Delete or modify each of the following items wherever appearing on Drawings, and/or Specifications. Acknowledge receipt of Addendum No. 1 in the space provided on the Contractor's Proposal. Failure to do so may subject bidder to disqualification.*

### **GENERAL:**

**Item Number 1:** Reference PlayCraft cut sheets submitted with DSA set. Replace with attached revised PlayCraft cut sheets.

The following changes were made:

- A. Three (3) "TOP VIEW (Footings)" pages were added for each playground element with a plan placing the post footing and a "Mount Locations Table" and "Mount Ordinate Table" to specify the size, depth, and location of the post footings.
- B. 06.1 concrete footing detail was added. Contractors to reference the tables mentioned in point A for footing widths and depths.

**DRAWINGS:**

**Item Number 2:** Reference sheet A-102 Enlarged Playground Plans; Replace this sheet with attached revised sheet A-102.

The following changes were made:

- A. Keynote SP01 was added. "ELEMENTARY SCHOOL PLAYGROUND EQUIPMENT, OWNER FURNISHED CONTRACTOR INSTALLED. INSTALLER MUST BE A CERTIFIED PLAYGROUND EQUIPMENT INSTALLER."
- B. The playground platform elevation markers were updated in the legend to match those in the plan.
- C. Keynote SP04 was updated to designate playground safety surface color.
- D. A 3'-0" wide perimeter band was added to the playground safety surface. Keynote SP15 was added to designate perimeter band color.

**Item Number 3:** Reference Civil's Sheet C-5.1 Detail Sheet; Replace this sheet with attached revised sheet C-5.1.

The following changes were made:

- A. In Detail 'E', the "type 2 sub-base – 95% compaction 4" min." was removed so that the "max pour safety surfacing top layer" can be poured into the concrete curb. And therefore, glue to it.
- B. In Detail 'E', the "#4 bars bent bars, @ 18" O.C. alternating" were added.
- C. In Detail 'C', the "type 2 sub-base – 95% compaction 4" min." was removed so that the "max pour safety surfacing top layer" can be poured into the concrete curb. And therefore, glue to it.
- D. In Detail 'C', the "#4 bars bent bars, @ 18" O.C. alternating" were added.
- E. Detail 'K' was added to detail how the rebar will attach to the post sleeve inside the concrete curb.

**PRE-BID RFI'S:**

**Item Number 4:** Please clarify the color of new rubberized safety surfacing to be installed. For example, 50% Standard Color / 50% Black or 100% Color mix to be determined.

**Response:** Reference revised sheet A-102 Enlarged Playground Plans keynote SP04 and SP15;

Field Color: 60% beige, 20% standard blue, 20% black

Perimeter Accent: Standard Blue

Addendum No. 1  
Smith Tech Academy Playground Upgrade Project  
Page 3

**Item Number 5:** Please clarify the binder type to be used within the top wear course layer of the new rubberized safety surfacing. Aromatic or Aliphatic?

**Response:** Aromatic. See section 32 18 16.13 – 2.3 Materials in the specifications.

**Item Number 6:** Please confirm the critical fall height of the new playground equipment. Reference Sheet A-102, “Playground Platform Elevations:” = 84” and Playground Notes #3. = 36.

**Response:** Reference revised sheet A-102 Enlarged Playground Plans legend Playground Platform Elevations.

**SUBSTITUTION REQUEST:**

**Item Number 7:** See attached approved Substitution Request for Playground Protective Surface.

END OF ADDENDUM NO. 1  
Pedro Jaramillo, AIA



*President*

# SMITH ELEMENTARY SPECIAL EDUCATION

PAC23B8EE6A



Presented by

**Pacific Play Systems, Inc.**

and



(800) 333-8519



# SMITH ELEMENTARY SPECIAL EDUCATION SITE PLAN

## ADA ACCESSIBILITY GUIDELINES - ADAAG CONFORMANCE

ELEVATED	ACCESSIBLE	RAMP ACCESSIBLE	GROUND	TYPES
6	6/3	0/0	9/2	8/2

**R5**

FOR KIDS  
AGES  
2-12

### GENERAL NOTES

This Preliminary Site Plan is based on measurements that were provided in the initial planning phase. All dimensions must be verified prior to the submission of a purchase order. Playcraft Systems will not be held responsible for any discrepancies between actual dimensions and dimensions submitted in the planning phase.

The Minimum Use Zone for a play structure is based on the product design at the time of proposal. Components and structure designs may be subject to change which may affect dimensions. Therefore, before preparing the site, we strongly recommend obtaining final drawings from the factory (available after the order is placed and included in the Assembly Manual).

**WARNING:** Accessible safety surfacing material is required beneath and around this equipment that has a critical height value (Fall Height) appropriate for the highest accessible part of this equipment. Refer to the CPSC'S Handbook For Public Playground Safety, Section 4: Surfacing.

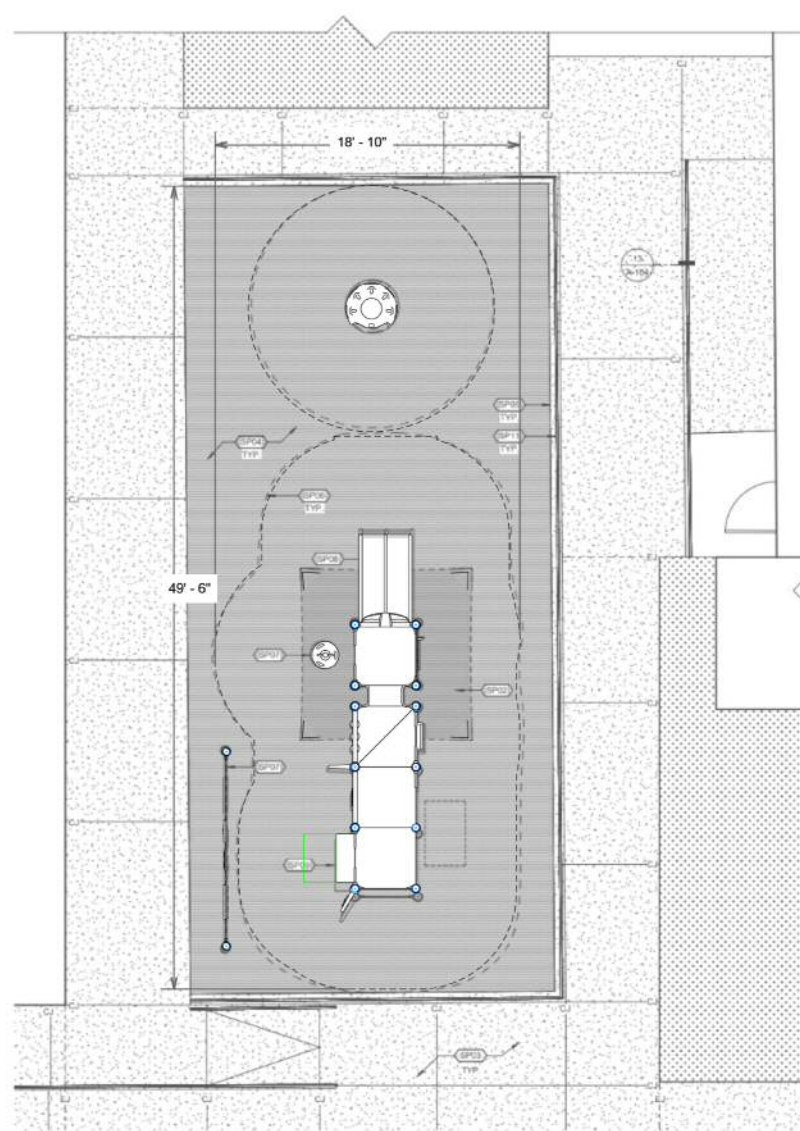
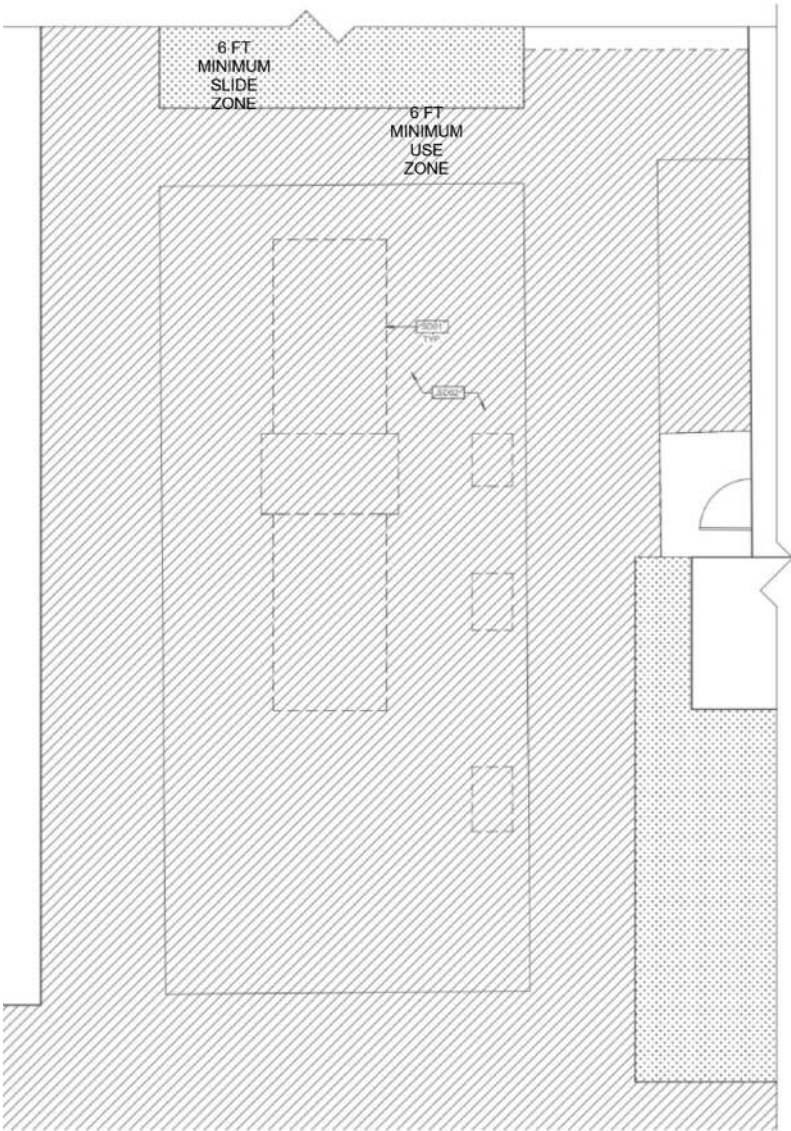

PROJECT # PAC23B8EE6A  
DATE 1/19/2024

**Pacific Play Systems, Inc.**  
MIN. USE ZONE 19' x 50' (5.743m x 15.107m)



# SMITH ELEMENTARY SPECIAL EDUCATION

## TOP VIEW

### ADA ACCESSIBILITY GUIDELINES - ADAAG CONFORMANCE

ELEVATED	ACCESSIBLE	RAMP ACCESSIBLE	GROUND	TYPES
5	5/3	0/0	3/2	2/2
CHILD CAPACITY 53		MAX FALL HEIGHT 36		

**R5**

FOR KIDS  
AGES  
2-12

#### GENERAL NOTES

This conceptual plan is based on information provided prior to construction. Detailed site information, including the following, should be obtained, evaluated, and utilized in the final project design. Exact site dimensions, topography, existing utilities, soil conditions and drainage solutions.

**WARNING:** Accessible safety surfacing material is required beneath and around this equipment that has a critical height value (Fall Height) appropriate for the highest accessible part of this equipment. Refer to the CPSC'S Handbook For Public Playground Safety, Section 4: Surfacing.

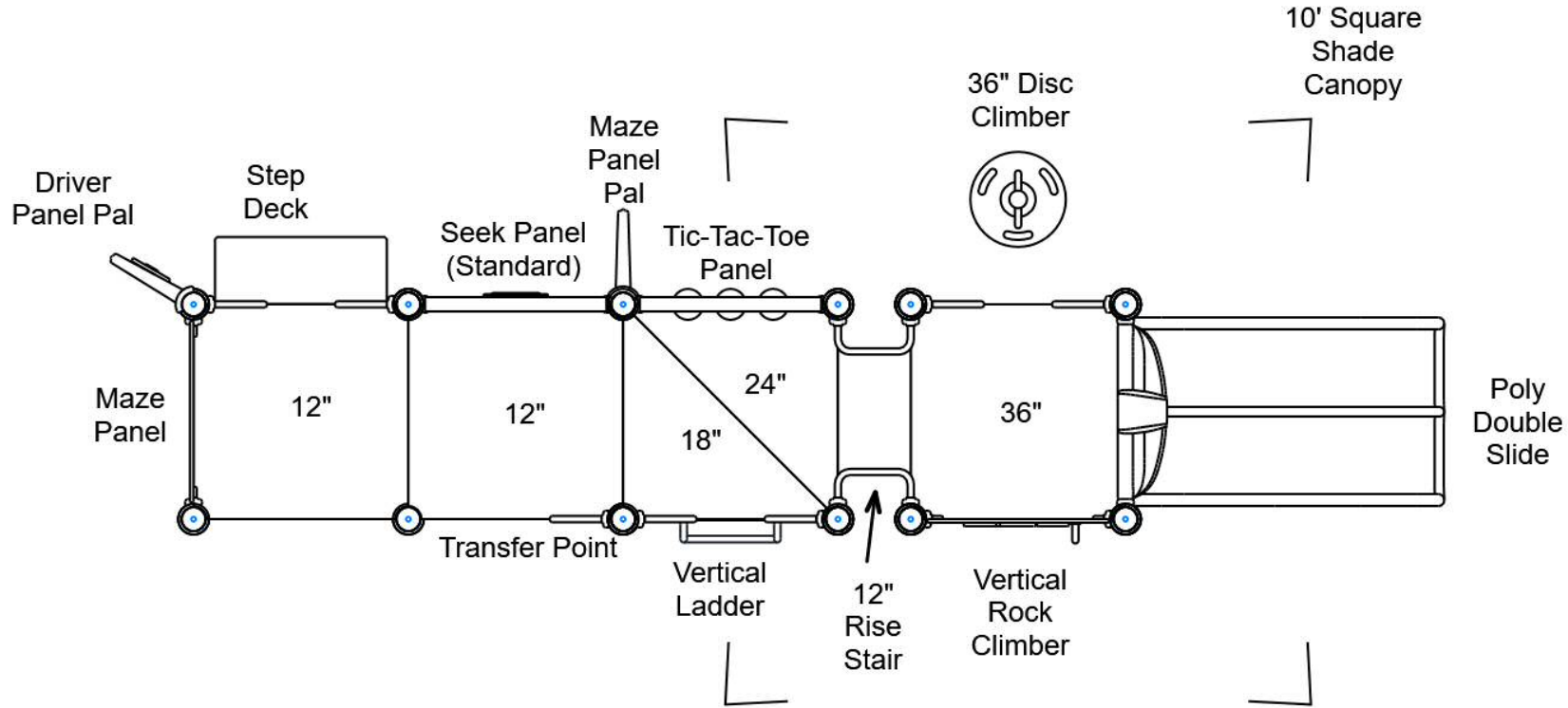

STRUCTURE # R50AB3AAA  
PROJECT # PAC23B8EE6A  
DATE 1/19/2024

**Pacific Play Systems, Inc.**

MIN. USE ZONE 35' x 19' (10.393m x 5.743m)



# SMITH ELEMENTARY SPECIAL EDUCATION

## TOP VIEW (Footings)

1

### ADA ACCESSIBILITY GUIDELINES - ADAAG CONFORMANCE

ELEVATED	ACCESSIBLE	RAMP ACCESSIBLE	GROUND	TYPES
5	5/3	0/0	3/2	2/2
CHILD CAPACITY	53	MAX FALL HEIGHT	36	

**R5**

FOR KIDS  
AGES  
2-12

MOUNT LOCATIONS TABLE			
#	TYPE	SIZE/DEPTH	LOCATIONS
A	EFO	W:12" x L:30" x D:15.5"	1
B	EF12	W:12" x L:12" x D:18"	2
C	EF12	W:12" x L:12" x D:16.5"	2
D	EF24	W:24" x L:24" x D:36"	1
E	PostFooting	W:18" x L:18" x D:30"	12

MOUNT ORDINATE TABLE			
#	X	Y	DIAG
1	0'-0"	0'-0"	0'-0"
2	0'-0"	-3'-9"	3'-9"
3	3'-9"	0'-0"	3'-9"
4	3'-9"	-3'-9"	5'-4"
5	7'-6"	0'-0"	7'-6"
6	7'-6"	-3'-9"	8'-5"
7	11'-3"	-3'-9"	11'-10"
8	11'-3"	0'-0"	11'-3"
9	12'-6"	0'-0"	12'-6"
10	12'-6"	-3'-9"	13'-1"
11	16'-3"	0'-0"	16'-3"
12	16'-3"	-3'-9"	16'-8"
13	1'-11"	0'-7"	2'-0"
14	8'-7"	-4'-1"	9'-6"
15	10'-2"	-4'-1"	11'-0"
16	14'-5"	1'-10"	14'-6"
17	21'-1"	-2'-8"	21'-3"
18	21'-1"	-1'-1"	21'-1"

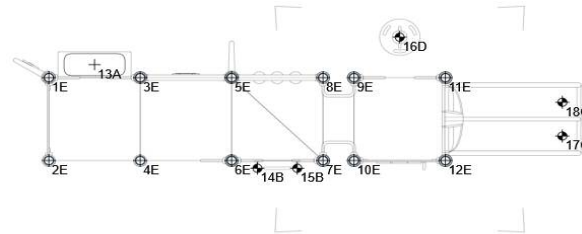

STRUCTURE # R50AB3AAA  
PROJECT # PAC23B8EE6A  
DATE 1/19/2024

**Pacific Play Systems, Inc.**

MIN. USE ZONE 35' x 19' (10.393m x 5.743m)



**SMITH ELEMENTARY SPECIAL EDUCATION**  
**SW VIEW**

**R5**

FOR KIDS  
AGES  
2-12

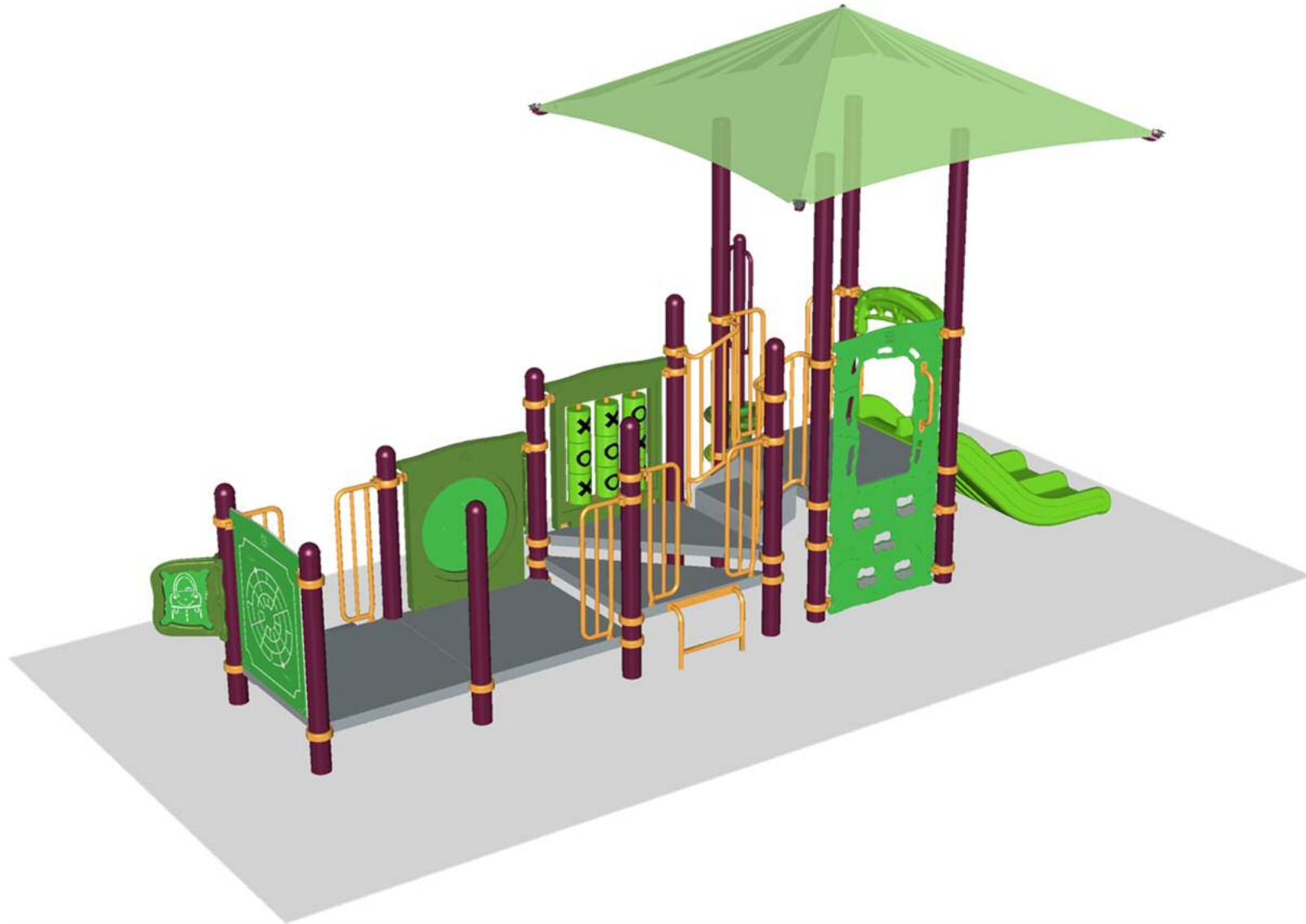

**STRUCTURE #** R50AB3AAA  
**PROJECT #** PAC23B8EE6A  
**DATE** 1/19/2024



**SMITH ELEMENTARY SPECIAL EDUCATION**  
**SE VIEW**

**R5**

FOR KIDS  
AGES  
2-12



**STRUCTURE #** R50AB3AAA  
**PROJECT #** PAC23B8EE6A  
**DATE** 1/19/2024

**SMITH ELEMENTARY SPECIAL EDUCATION**  
**NE VIEW**

**R5**

FOR KIDS  
AGES  
2-12



**STRUCTURE #** R50AB3AAA  
**PROJECT #** PAC23B8EE6A  
**DATE** 1/19/2024

**SMITH ELEMENTARY SPECIAL EDUCATION**  
**NW VIEW**

**R5**

FOR KIDS  
AGES  
2-12



**STRUCTURE #** R50AB3AAA  
**PROJECT #** PAC23B8EE6A  
**DATE** 1/19/2024

# SMITH ELEMENTARY SPECIAL EDUCATION

## TOP VIEW

### ADA ACCESSIBILITY GUIDELINES - ADAAG CONFORMANCE

ELEVATED	ACCESSIBLE	RAMP ACCESSIBLE	GROUND	TYPES
0	0/0	0/0	5/0	3/0
CHILD CAPACITY	5	MAX FALL HEIGHT	0	



#### GENERAL NOTES

This conceptual plan is based on information provided prior to construction. Detailed site information, including the following, should be obtained, evaluated, and utilized in the final project design. Exact site dimensions, topography, existing utilities, soil conditions and drainage solutions.

WARNING: Accessible safety surfacing material is required beneath and around this equipment that has a critical height value (Fall Height) appropriate for the highest accessible part of this equipment. Refer to the CPSC'S Handbook For Public Playground Safety, Section 4: Surfacing.

### Sensory Play Wall Cognitive



STRUCTURE # R5095B58A  
PROJECT # PAC23B8EE6A  
DATE 1/19/2024

**Pacific Play Systems, Inc.**

MIN. USE ZONE 13' x 1' (3.784m x 0.127m)





# SMITH ELEMENTARY SPECIAL EDUCATION

## TOP VIEW (Footings)

1

### ADA ACCESSIBILITY GUIDELINES - ADAAG CONFORMANCE

ELEVATED	ACCESSIBLE	RAMP ACCESSIBLE	GROUND	TYPES
0	0/0	0/0	5/0	3/0
CHILD CAPACITY	5	MAX FALL HEIGHT	0	



FOR KIDS  
AGES  
2-12

MOUNT LOCATIONS TABLE			
#	TYPE	SIZE/DEPTH	LOCATIONS
A	EF12	W:12" x L:12" x D:18"	2
B	PostFooting	W:18" x L:18" x D:30"	2

MOUNT ORDINATE TABLE			
#	X	Y	DIAG
1	0'-0"	0'-0"	0'-0"
2	12'-0"	0'-0"	12'-0"
3	4'-2"	0'-0"	4'-2"
4	7'-10"	0'-0"	7'-10"



STRUCTURE # R5095B58A  
PROJECT # PAC23B8EE6A  
DATE 1/19/2024

**Pacific Play Systems, Inc.**

MIN. USE ZONE 13' x 1' (3.784m x 0.127m)



**SMITH ELEMENTARY SPECIAL EDUCATION**  
**SW VIEW**

**R5**

FOR KIDS  
AGES  
2-12

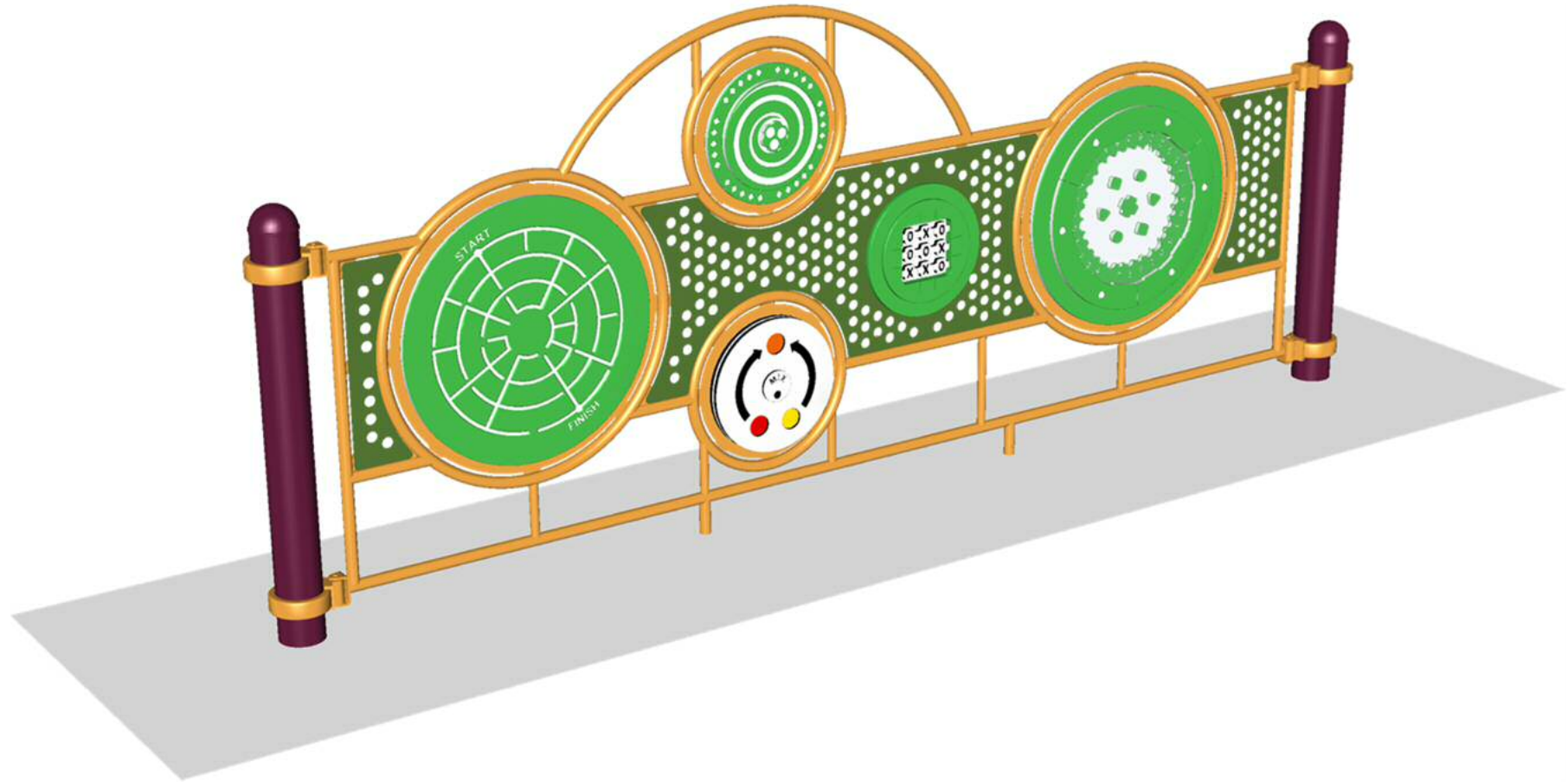

**STRUCTURE #** R5095B58A  
**PROJECT #** PAC23B8EE6A  
**DATE** 1/19/2024

**SMITH ELEMENTARY SPECIAL EDUCATION**  
**SE VIEW**

**R5**

FOR KIDS  
AGES  
2-12

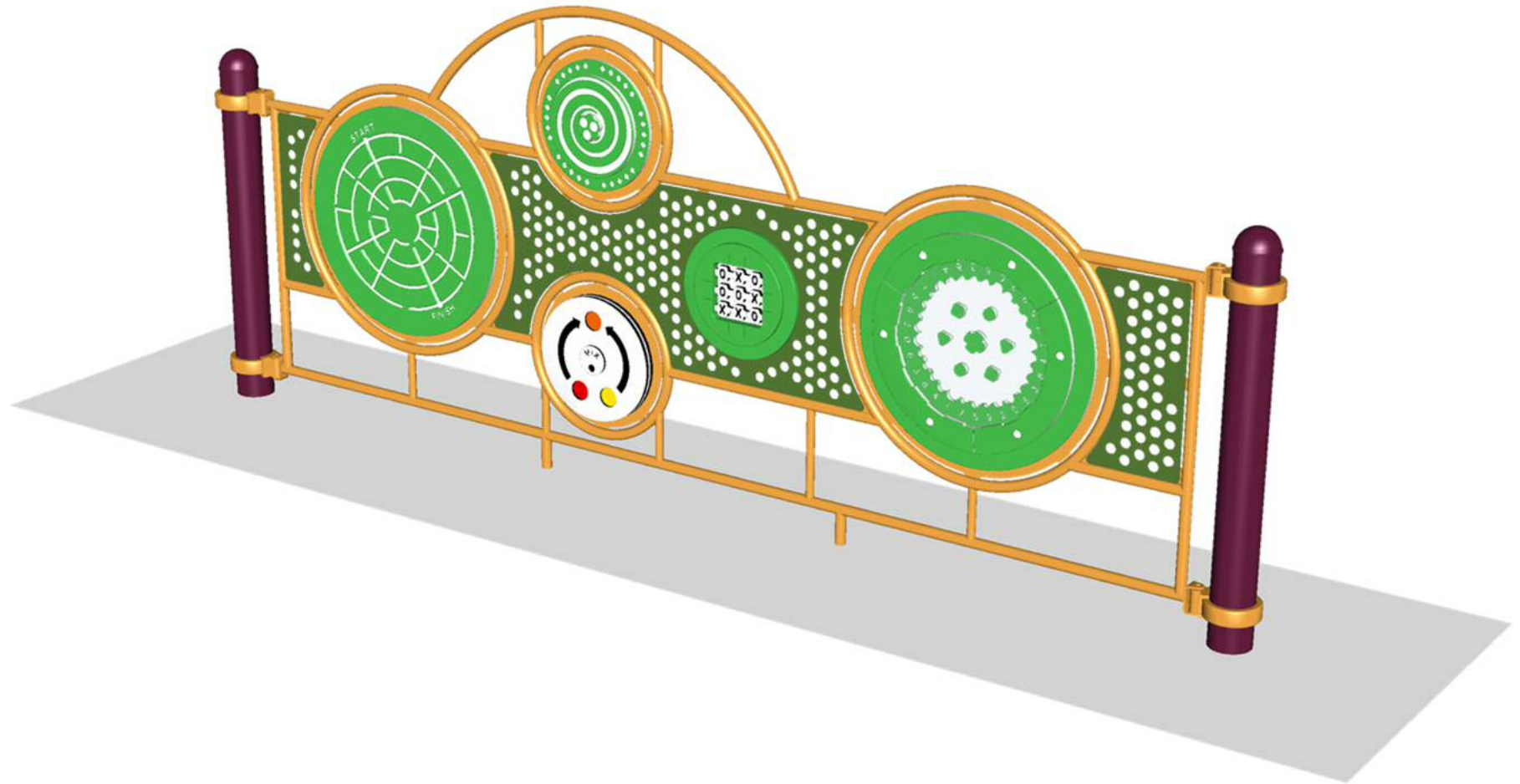

**STRUCTURE #** R5095B58A  
**PROJECT #** PAC23B8EE6A  
**DATE** 1/19/2024

**SMITH ELEMENTARY SPECIAL EDUCATION**  
**NE VIEW**

**R5**

FOR KIDS  
AGES  
2-12

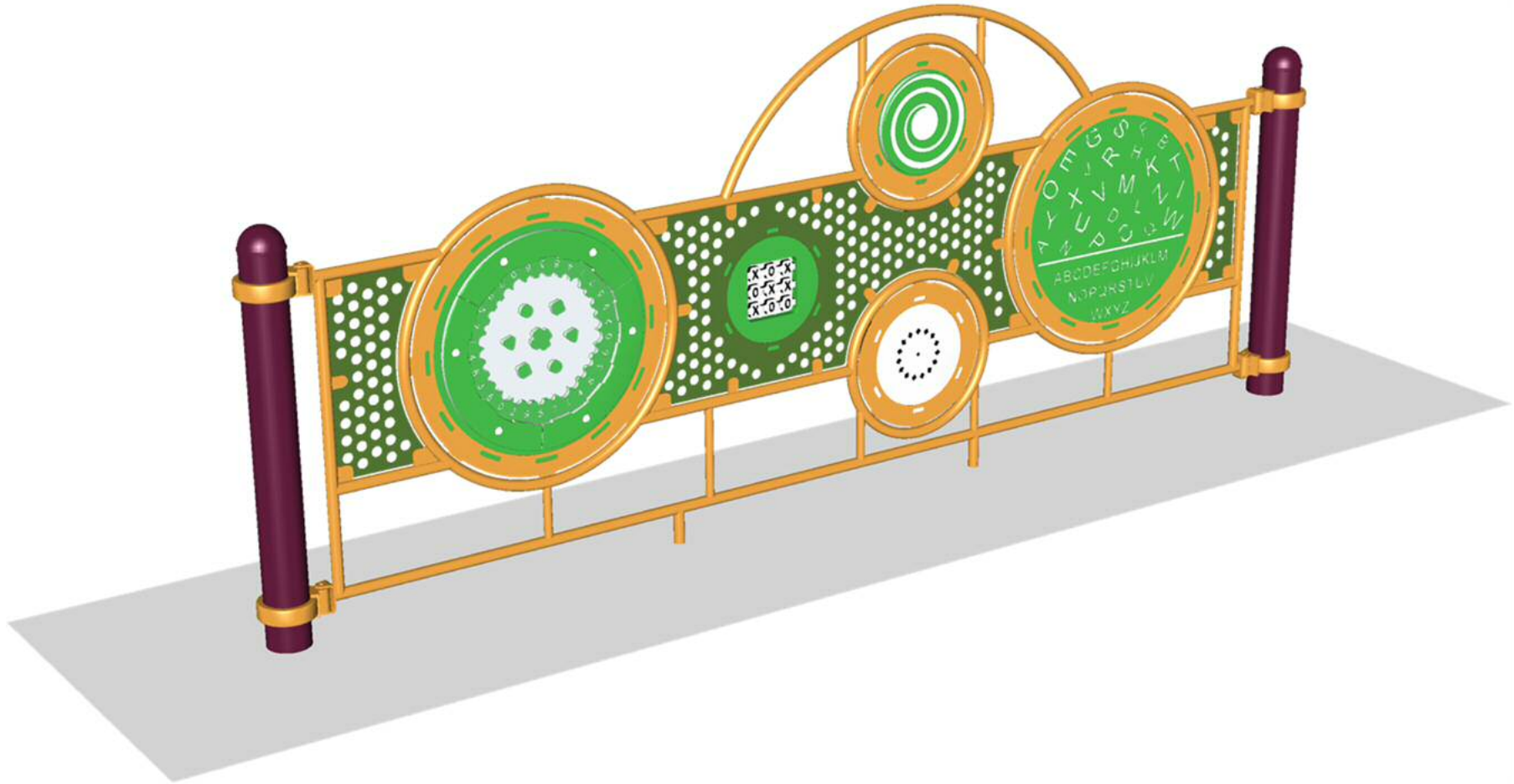

**STRUCTURE #** R5095B58A  
**PROJECT #** PAC23B8EE6A  
**DATE** 1/19/2024



**SMITH ELEMENTARY SPECIAL EDUCATION**  
**NW VIEW**

**R5**

FOR KIDS  
AGES  
2-12

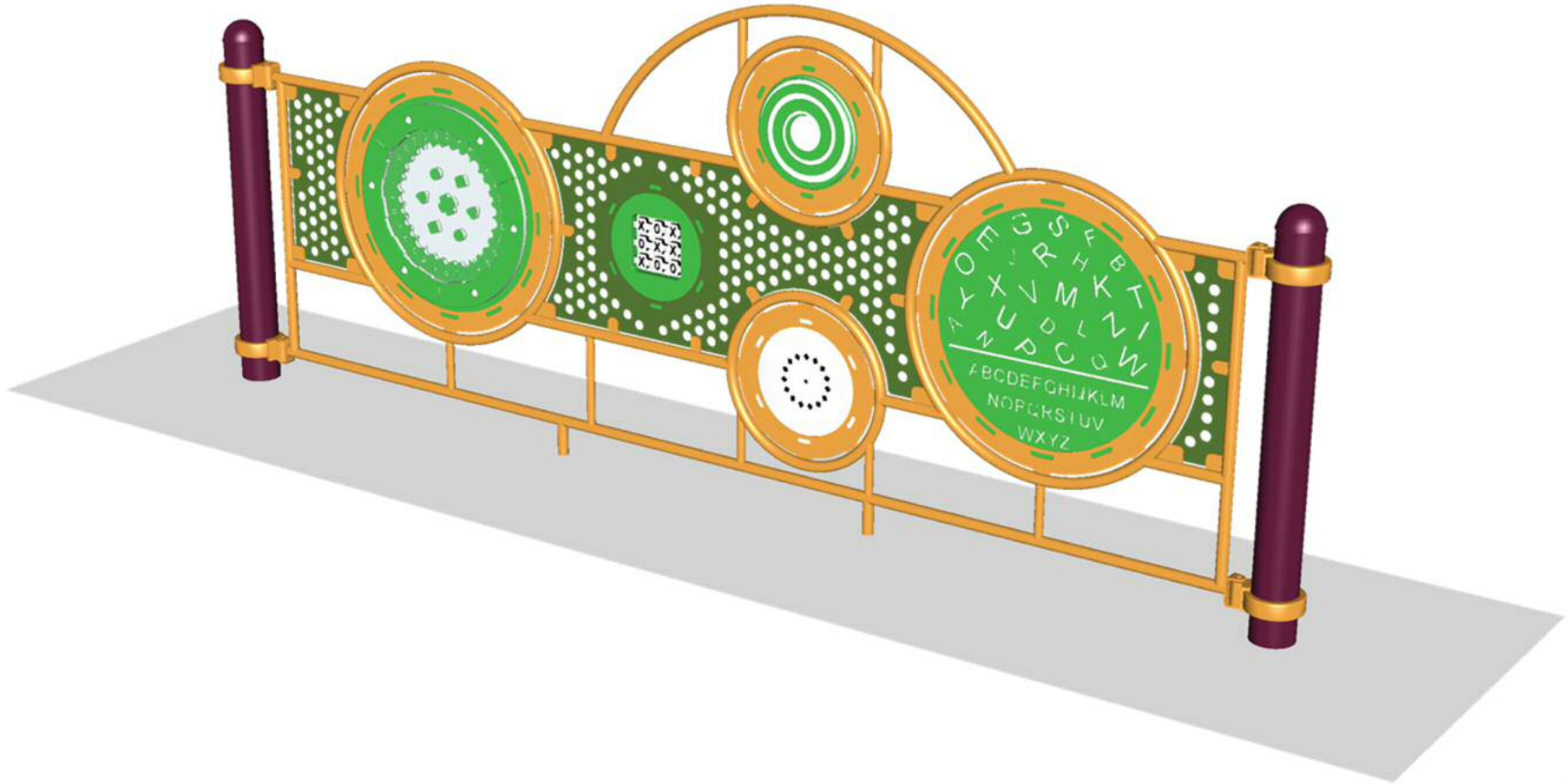

**STRUCTURE #** R5095B58A  
**PROJECT #** PAC23B8EE6A  
**DATE** 1/19/2024

# SMITH ELEMENTARY SPECIAL EDUCATION

## TOP VIEW

### ADA ACCESSIBILITY GUIDELINES - ADAAG CONFORMANCE

ELEVATED	ACCESSIBLE	RAMP ACCESSIBLE	GROUND	TYPES
0	0/0	0/0	1/0	1/0
CHILD CAPACITY	2	MAX FALL HEIGHT	12	

FOR KIDS  
AGES  
2-12

PC  
2478  
SPIN  
MAX  
POD

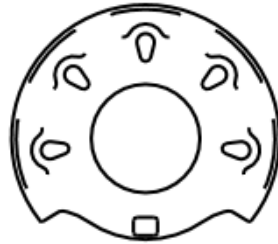

#### GENERAL NOTES

This conceptual plan is based on information provided prior to construction. Detailed site information, including the following, should be obtained, evaluated, and utilized in the final project design. Exact site dimensions, topography, existing utilities, soil conditions and drainage solutions.

WARNING: Accessible safety surfacing material is required beneath and around this equipment that has a critical height value (Fall Height) appropriate for the highest accessible part of this equipment. Refer to the CPSC'S Handbook For Public Playground Safety, Section 4: Surfacing.

STRUCTURE # FREPC2478  
PROJECT # PAC23B8EE6A  
DATE 1/19/2024

**Pacific Play Systems, Inc.**

MIN. USE ZONE 16' x 16' (4.628m x 4.628m)



# SMITH ELEMENTARY SPECIAL EDUCATION

## TOP VIEW (Footings)

1

### ADA ACCESSIBILITY GUIDELINES - ADAAG CONFORMANCE

ELEVATED	ACCESSIBLE	RAMP ACCESSIBLE	GROUND	TYPES
0	0/0	0/0	1/0	1/0
CHILD CAPACITY	2	MAX FALL HEIGHT	12	

FOR KIDS  
AGES  
2-12

MOUNT LOCATIONS TABLE

#	TYPE	SIZE/DEPTH	LOCATIONS
A	EF36	W:36" x L:36" x D:36"	1

MOUNT ORDINATE TABLE

#	X	Y	DIAG
---	---	---	------



STRUCTURE # FREPC2478  
PROJECT # PAC23B8EE6A  
DATE 1/19/2024

**Pacific Play Systems, Inc.**

MIN. USE ZONE 16' x 16' (4.628m x 4.628m)



**SMITH ELEMENTARY SPECIAL EDUCATION  
SW VIEW**

FOR KIDS  
AGES  
2-12

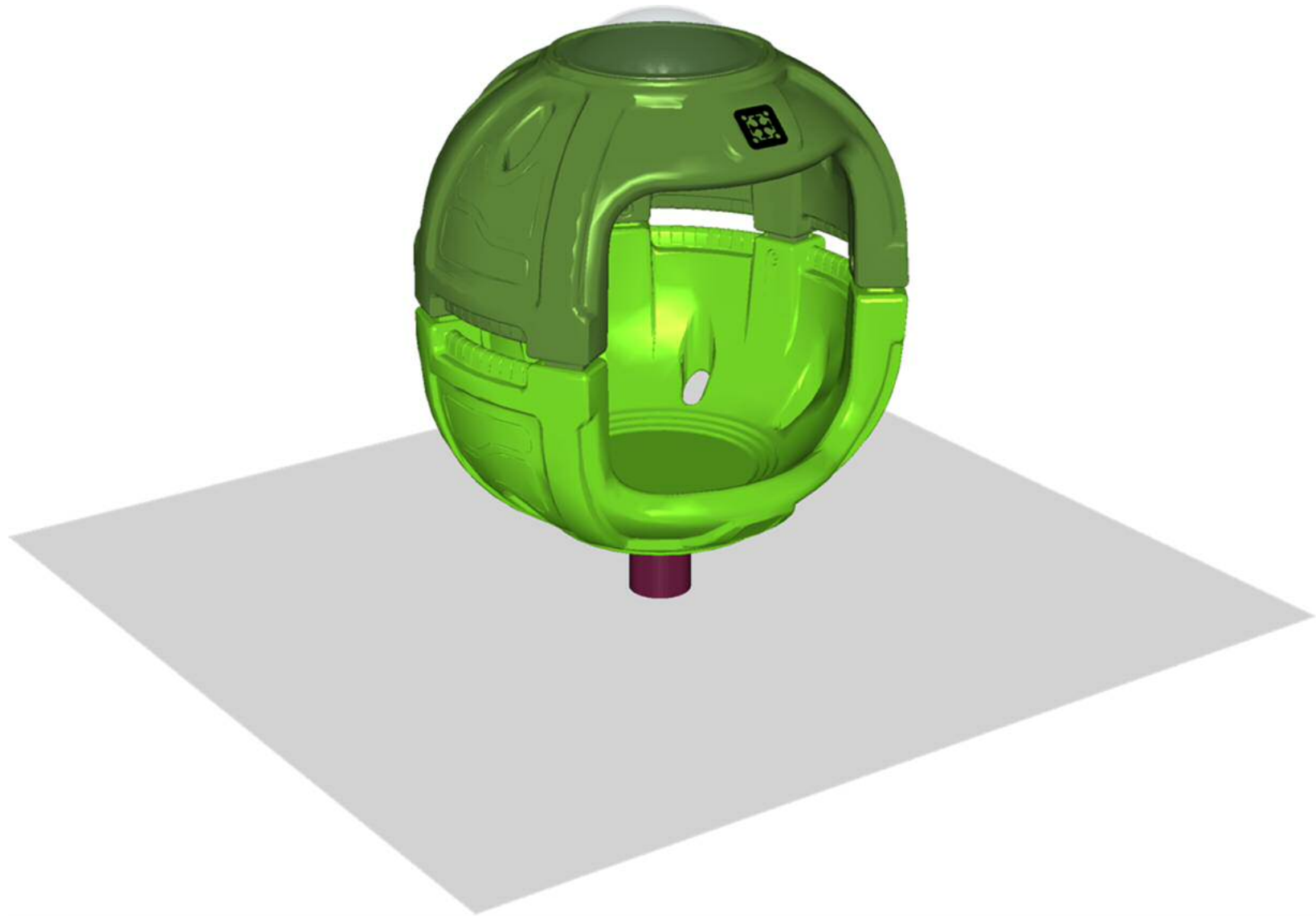

**STRUCTURE #** FREPC2478  
**PROJECT #** PAC23B8EE6A  
**DATE** 1/19/2024



**SMITH ELEMENTARY SPECIAL EDUCATION  
SE VIEW**

FOR KIDS  
AGES  
2-12

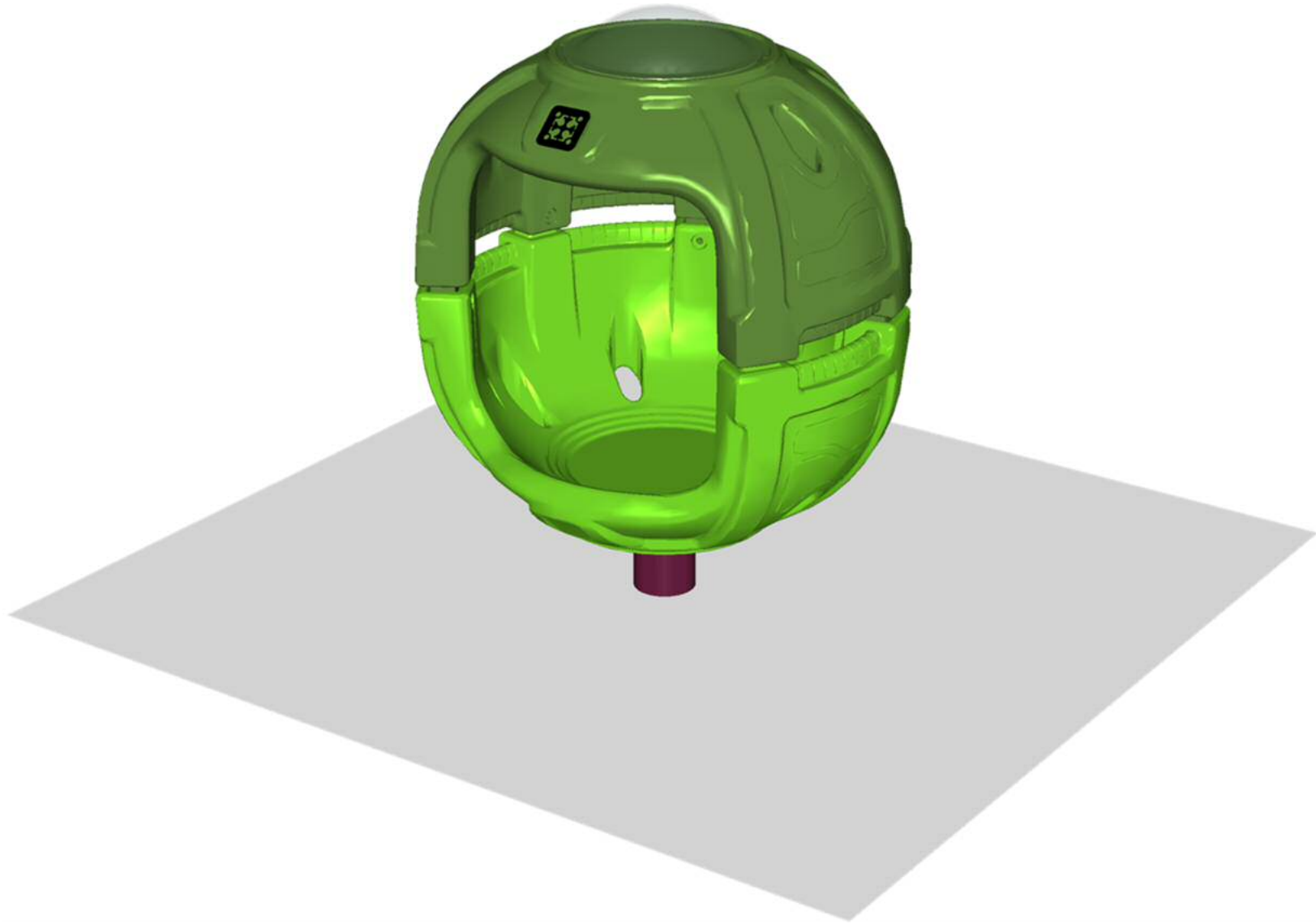

**STRUCTURE #** FREPC2478  
**PROJECT #** PAC23B8EE6A  
**DATE** 1/19/2024

**SMITH ELEMENTARY SPECIAL EDUCATION  
NE VIEW**

FOR KIDS  
AGES  
2-12

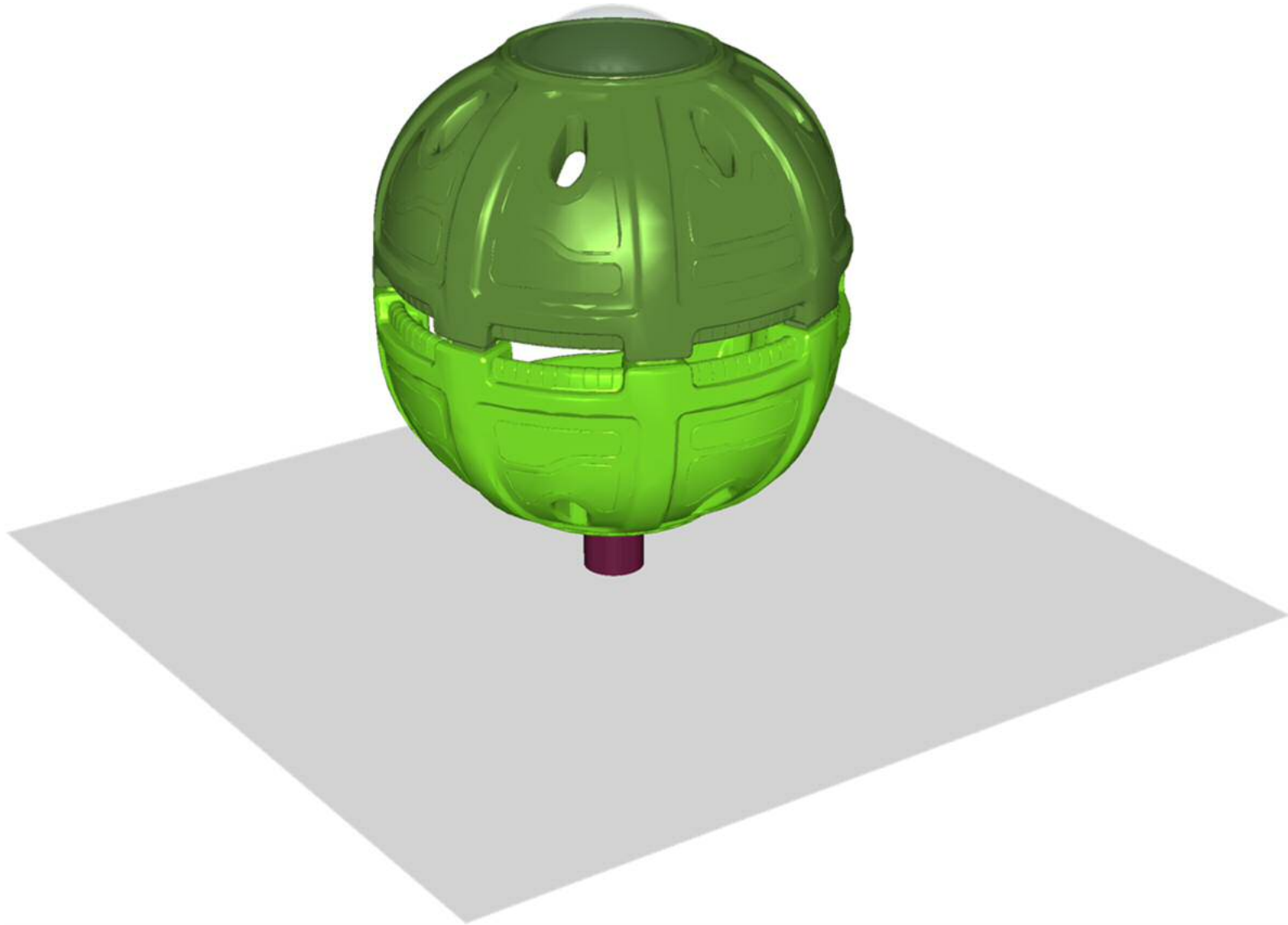

**STRUCTURE #** FREPC2478  
**PROJECT #** PAC23B8EE6A  
**DATE** 1/19/2024

**SMITH ELEMENTARY SPECIAL EDUCATION  
NW VIEW**

FOR KIDS  
AGES  
2-12

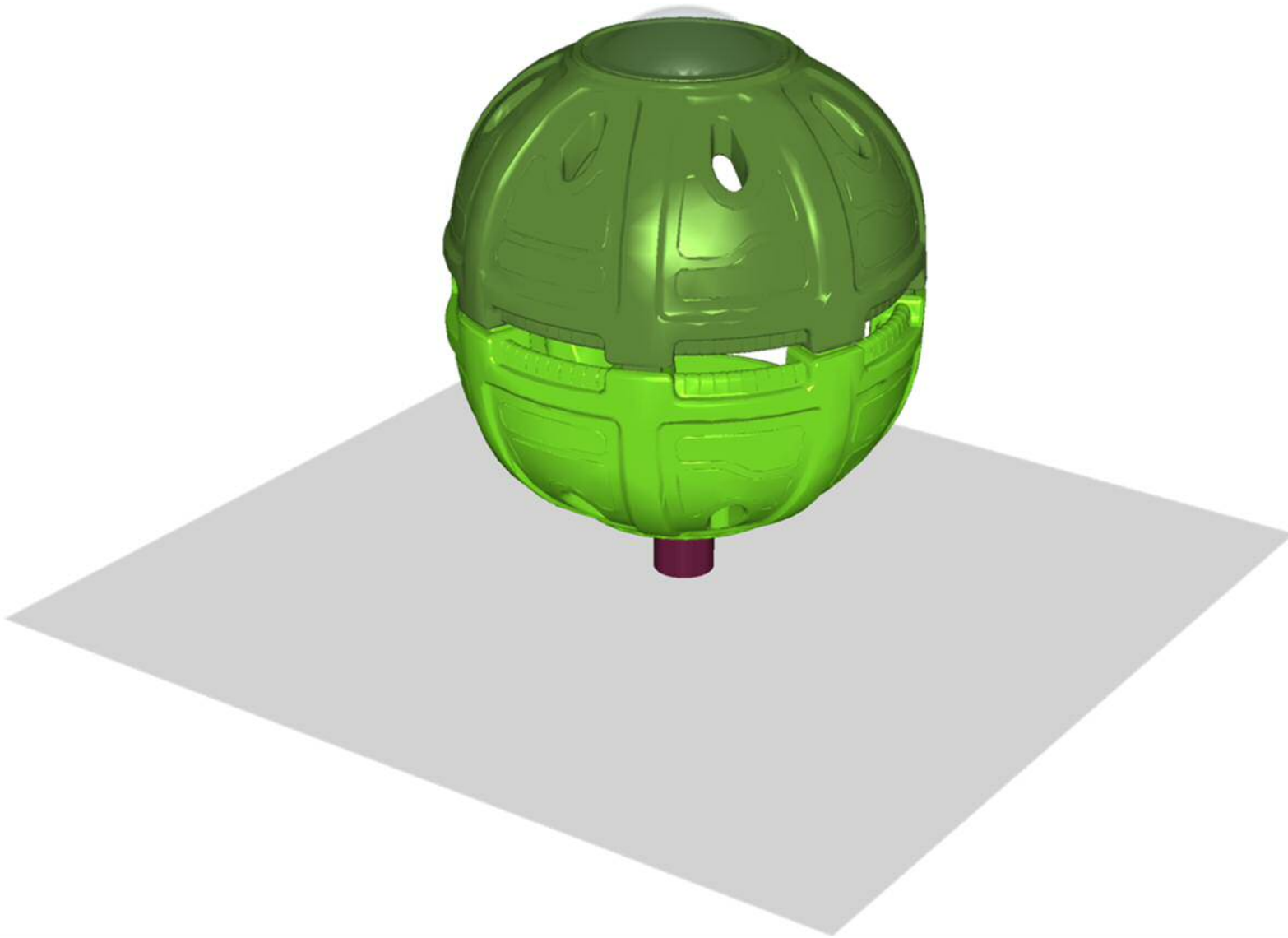

**STRUCTURE #** FREPC2478  
**PROJECT #** PAC23B8EE6A  
**DATE** 1/19/2024

**SMITH ELEMENTARY SPECIAL EDUCATION**

**Project #** PAC23B8EE6A

**Date** 1/19/2024

<b>Item / Part Number</b>	<b>Description</b>	<b>Qty</b>
<b>[R50AB3AAA]</b>		
HS-1004-R	Collars	37
GF-7002	Dome Cap, R5	8
S-1008-R5-08ft	Post, 08ft R5	4
S-1009-R5-09ft	Post, 09ft R5	2
S-1010-R5-10ft	Post, 10ft R5	2
S-1014-R5-14ft	Post, 14ft R5	4
S-1101-R5	Square Deck	3
S-1105-R5	Half Deck	2
S-1202-R5	Step Deck, 12in	1
S-1206-12R5	ADA Stairs, 12in Rise w/ Walls	1
S-1210-24	Climber, Vertical Ladder 18-24in	1
S-1233-3-HW	Climber, Disc 30-36in (w/ HW)	1
S-1237-3R5	Climber, Vertical Rock 30-36in	1
S-1306-R5	Double Slide SitDown Hood	1
S-1309-2-R5	Half Walls (Pair) R5	2
S-1309-R5	Transfer Point (Half Wall - Right)	1
S-1607-R5	Maze Panel	1
S-1616-R5	Tic-Tac-Toe Panel	1
S-1618-R5	Seek Panel (Standard)	1
S-1663-R5	Panel Pal, Maze	1
S-1667-R5	Panel Pal, Driver	1
S-1702-3R5	Slide, Double 36in	1
S-18021-10R5	Shade Canopy, 10ft Square	1
<b>[R5095B58A]</b>		
HS-1004-R	Collars	5
GF-7002	Dome Cap, R5	2
S-1007-R5-07ft	Post, 07ft R5	2
S-1981-SWC	Sensory Play Wall (Cognitive)	1
<b>[FREPC2478]</b>		
A2-2478	PC 2478 Spin Max Pod	1

# CONCRETE FOOTINGS

**IMPORTANT:** The footing depth for support posts and other equipment must be adjusted to compensate for depth / thickness requirements of the selected impact attenuating safety surface. (i.e. wood chips vs. rubber matting).

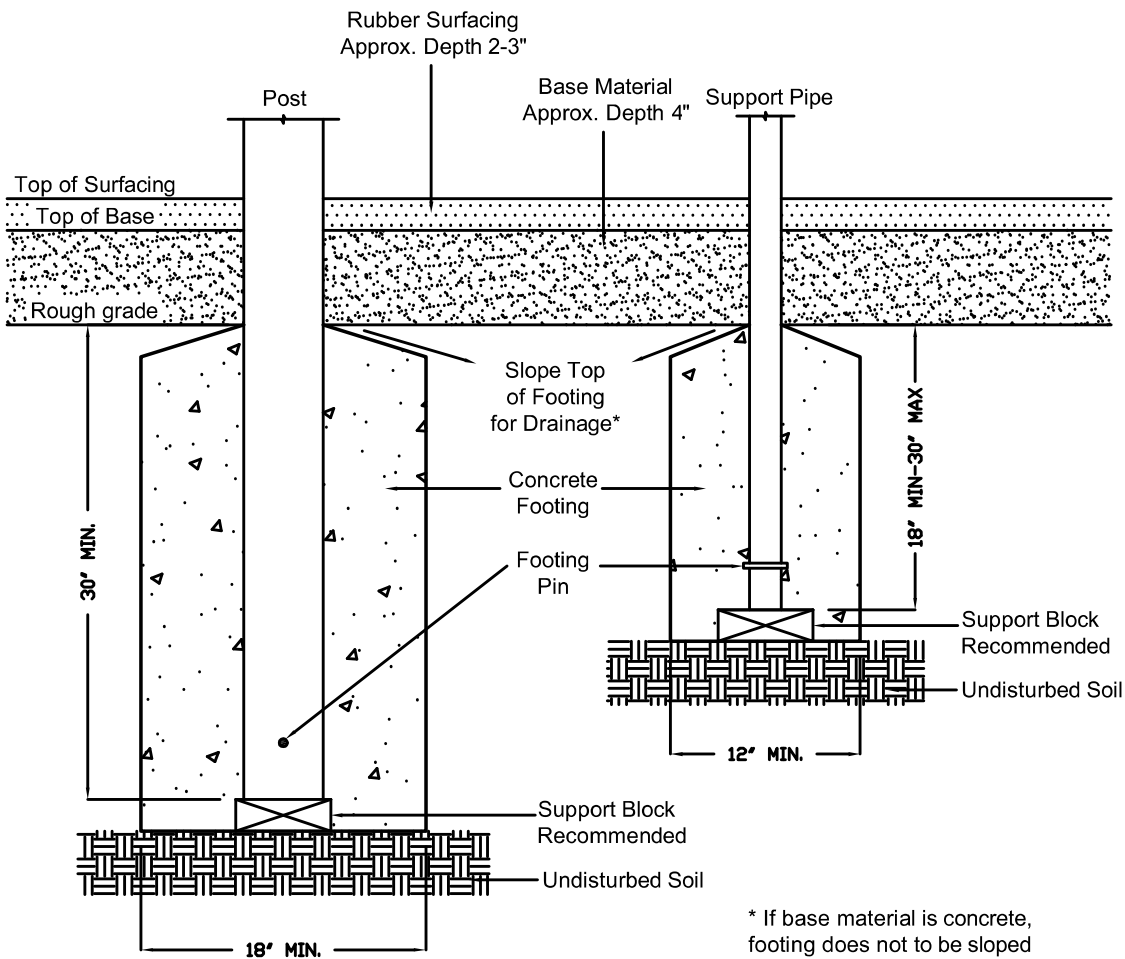
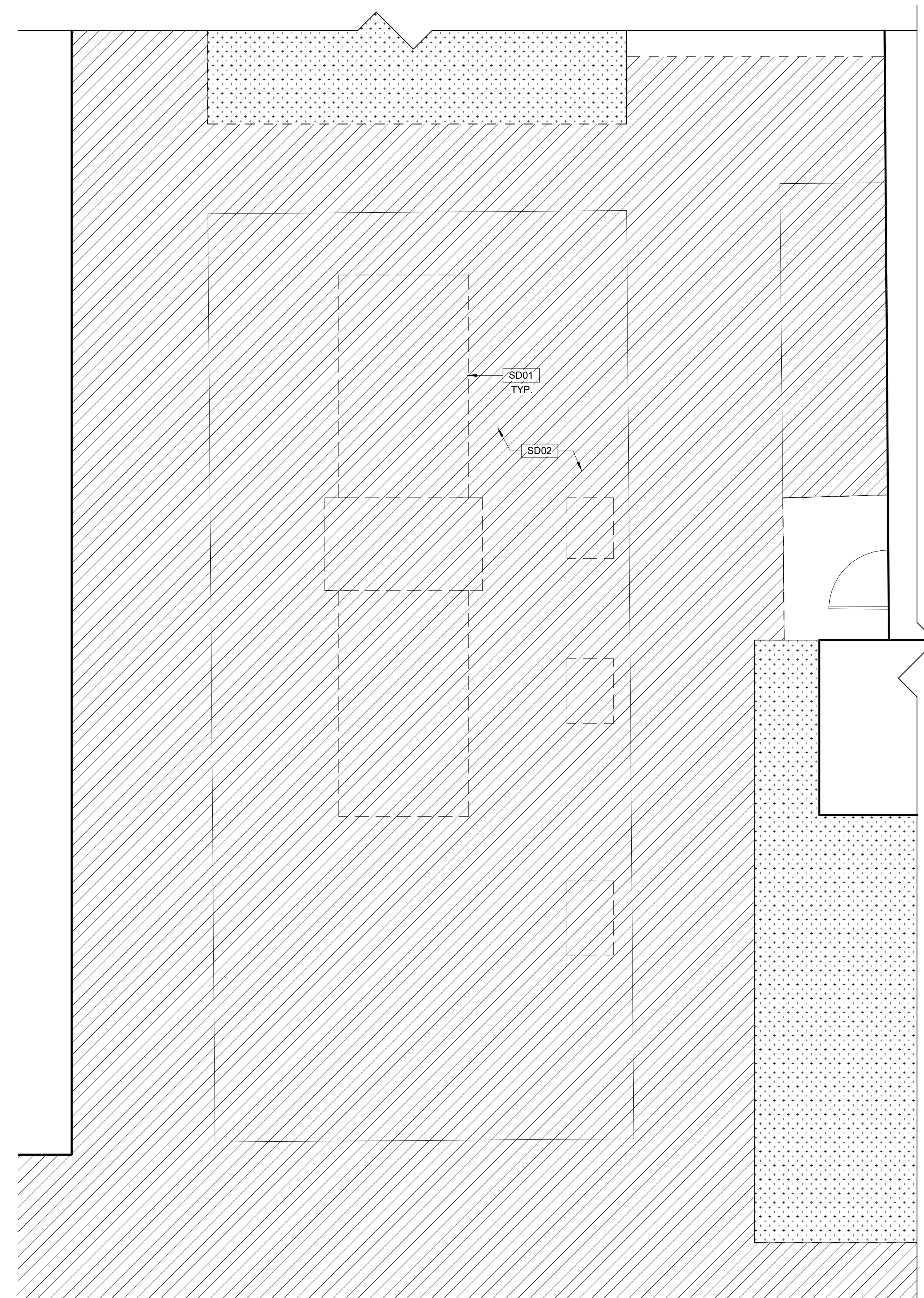

Figure 6.1.

\* If base material is concrete, footing does not to be sloped  
 \* Refer to mounting tables for measurements.

## IMPORTANT:

<b>1</b>	Use more concrete as required for supporting activities with movement such as the Track Rides, Traverses, Chinning Bars and Swings.
<b>2</b>	See specific Swing Assembly Instructions for swing post footings and ground cover requirements.
<b>3</b>	Larger footings (more concrete) may also be required due to weather conditions and poor (unstable, loose or granitic) soil. Before changing footing dimensions we recommend that the footings be reviewed and approved by a registered Engineer.
<b>4</b>	Base of the footing must be below the frost line. Determine depth of frost line for your area and adjust footing depth (not post and support depth) as required.



**1 ENLARGED DEMO PLAYGROUND**  
SCALE: 1/4" = 1'-0"

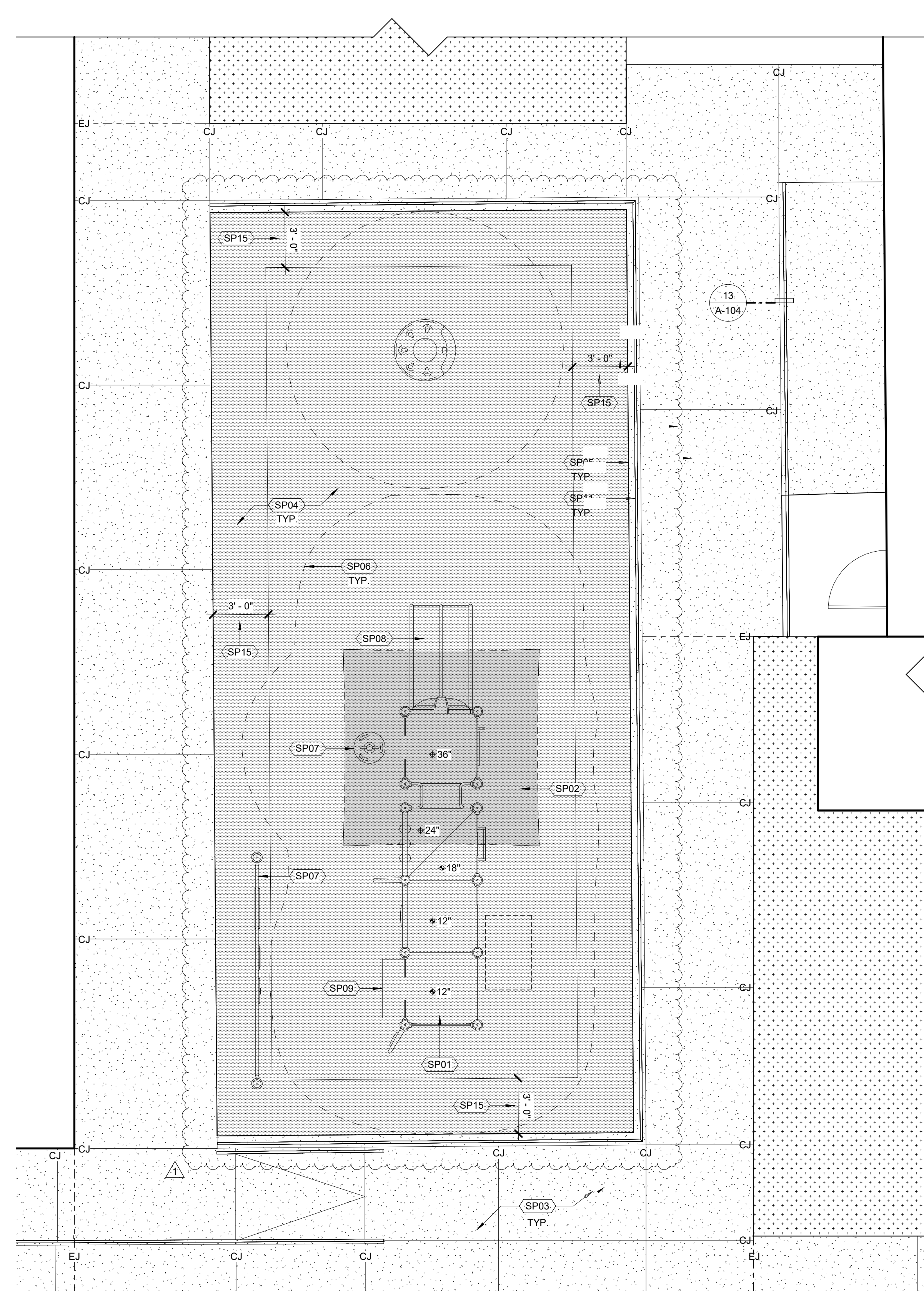

**2 ENLARGED PLAYGROUND**  
SCALE: 1/4" = 1'-0"

- DEMO KEYNOTES**
- SD01 REMOVE EXISTING PLAYGROUND EQUIPMENT AND ASSOCIATED FOOTINGS.
  - SD02 REMOVE EXISTING PLAYGROUND SAFETY SURFACE.

- NEW WORK KEYNOTES**
- SP01 ELEMENTARY SCHOOL PLAYGROUND EQUIPMENT, OWNER FURNISHED CONTRACTOR INSTALLED. INSTALLER MUST BE A CERTIFIED PLAYGROUND EQUIPMENT INSTALLER.
  - SP02 10'-0" x 10'-0" SAIL SHADE STRUCTURE ABOVE.
  - SP03 CONCRETE PAVING. SEE CIVIL DRAWINGS FOR MORE INFORMATION.
  - SP04 PLAYGROUND RUBBERIZED SAFETY SURFACE. ROSEHILL TYP COLOR AS USED BY PLAYMAX 10% BEIGE, 20% STANDARD BLUE, 20% BLACK.
  - SP05 8" WIDE CONCRETE CURB.
  - SP06 FALL ZONE OUTLINE.
  - SP07 GROUND LEVEL COMPONENT.
  - SP08 ELEVATED LEVEL COMPONENT.
  - SP09 PROVIDE PAINTED CONTRASTING STRIPE MINIMUM 2" WIDE x FULL STAIR LENGTH PLACED NO MORE THAN 1" INCH FROM THE NOSE OF THE STAIR. COLOR TO BE "CAUTION YELLOW". TYP. AT ALL STEPS.
  - SP11 WROUGHT-IRON 4'-0" FENCE.
  - SP15 PLAYGROUND RUBBERIZED SAFETY SURFACE. 3'-0" WIDE PERIMETER BAND ALL AROUND. ROSEHILL TYP COLOR AS USED BY PLAYMAX STANDARD BLUE RH20.

- LEGEND**
- ASSUMED PROPERTY LINE
  - EXISTING FENCE LINE
  - (E) BUILDING
  - (E) TURF / LANDSCAPING
  - DEMO
  - (N) AC PAVING
  - (N) CONCRETE PAVING
  - (N) RUBBERIZED SAFETY SURFACE

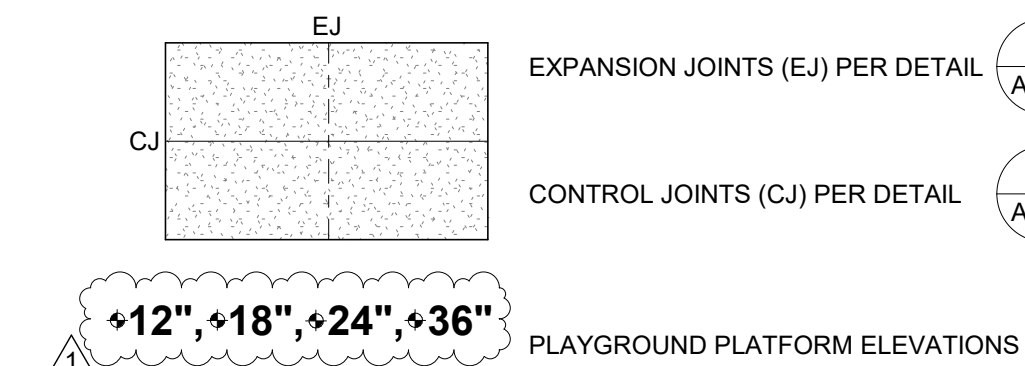

- PLAYGROUND NOTES**
1. RECOMMENDED AGES: 2-12
  2. PLAY STRUCTURE AND LAYOUT OF COMPONENTS CONFORM TO ASTM F-1487-17 AND CPSC'S 325 GUIDELINES AND COR TITLE 22, DIVISION 4, CHAPTER 22.
  3. CRITICAL FALL HEIGHT OF OVERALL PLAY AREA: 36'.

**NUMBER AND TYPES OF GROUND LEVEL PLAY COMPONENTS REQUIRED TO BE ON ACCESSIBLE ROUTES**

# OF ELEVATED PLAY COMPONENTS PROVIDED	6
# OF ELEVATED PLAY COMPONENTS ACCESSIBLE BY TRANSFER	11
MINIMUM # OF GROUND COMPONENTS REQUIRED	2
MINIMUM # OF GROUND COMPONENTS PROVIDED	8
MINIMUM # OF DIFFERENT TYPES OF GROUND LEVEL PLAY COMPONENTS REQUIRED	2
MINIMUM # OF DIFFERENT TYPES OF GROUND LEVEL PLAY COMPONENTS PROVIDED	3

**NOTE:** FOR MORE INFORMATION SEE GROUND LEVEL AND ELEVATED PLAY COMPONENTS TABLE, DETAIL 30/A-104.

APPROVAL

ARCHITECT STAMP CONSULTANT STAMP

LICENSED ARCHITECT  
NO. C33951  
REN. 10-31-23  
STATE OF CALIFORNIA

CONSULTANT LOGO

**PLAYGROUND ENHANCEMENTS @  
GERALD A. SMITH ELEMENTARY  
SCHOOL**

COLTON JOINT UNIFIED SCHOOL DISTRICT

NO. DATE ISSUE  
11/27/23 01/25/2024 ADDENDUM NO. 01

PROJECT NO.  
11951

DRAWN BY DS CHECKED BY LZ

DATE  
11/27/23

DRAWING TITLE  
**ENLARGED PLAYGROUND PLANS**

**A-102**



J:\04.31 GERALD A. SMITH ELEMENTARY - PLAYGROUND REPLACEMENT\_CIVIL 3D\PLAN - ONSITE\04\_31-C-05.DWG

PLotted on 11/09/23 10:58 AM. PLOT SCALE: 1/8" = 1'-0". PLOT AREA: 11.00 X 17.00. PLOT DIMENSIONS: 11.00 X 17.00. PLOT AREA: 187.00 SQ. FT.

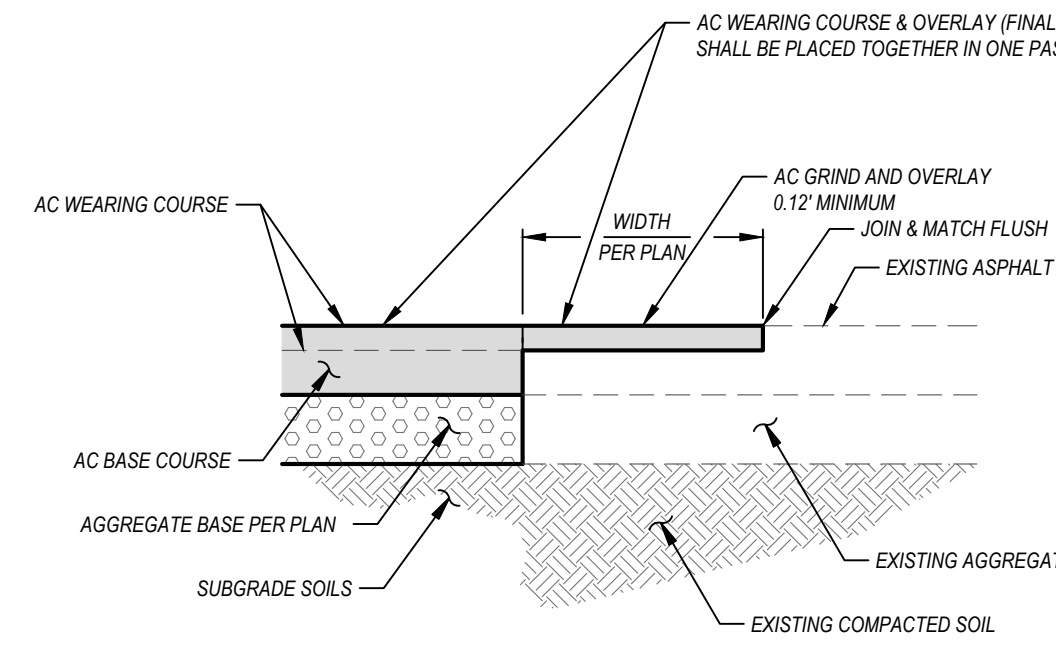

GRIND AND OVERLAY

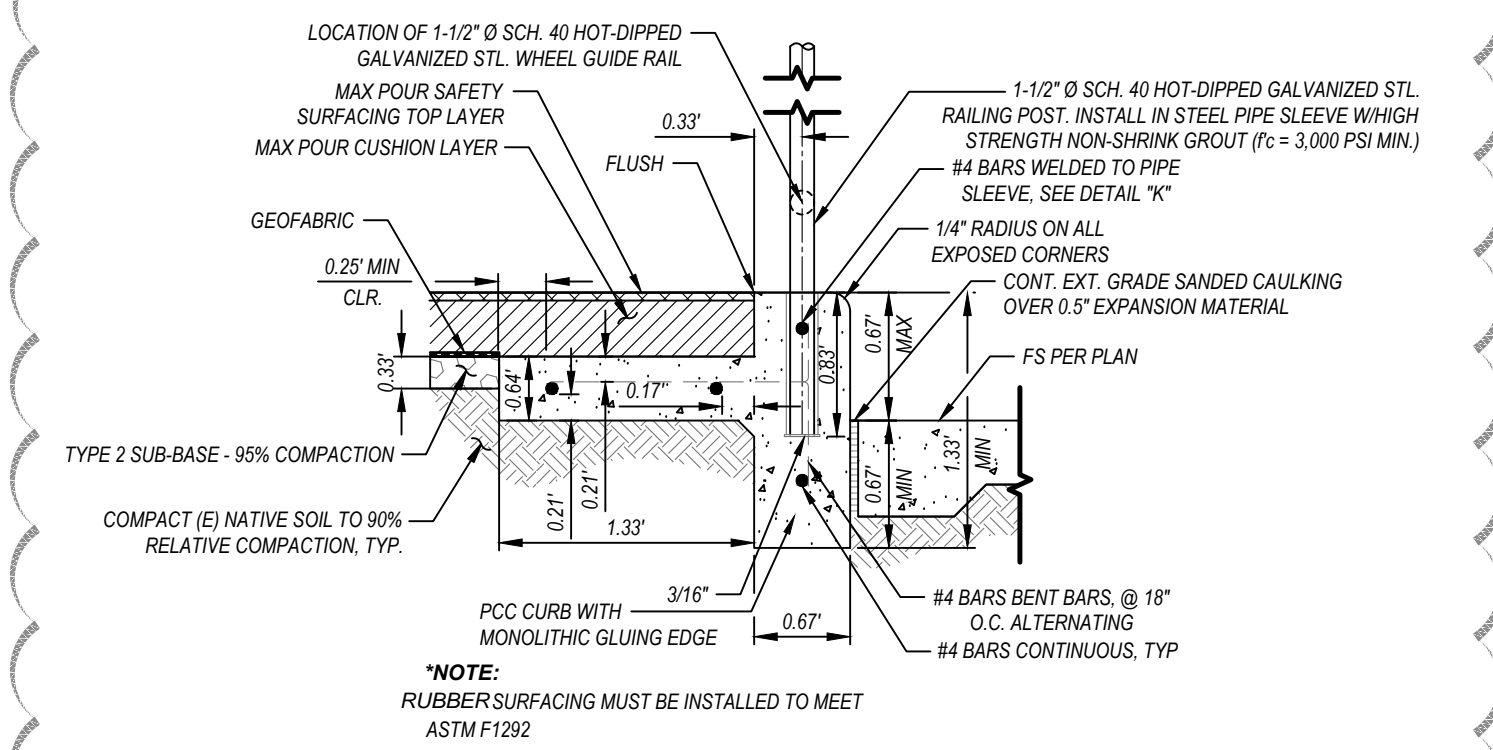

DETAIL "C" CURB CONDITION WITH RAILING POST

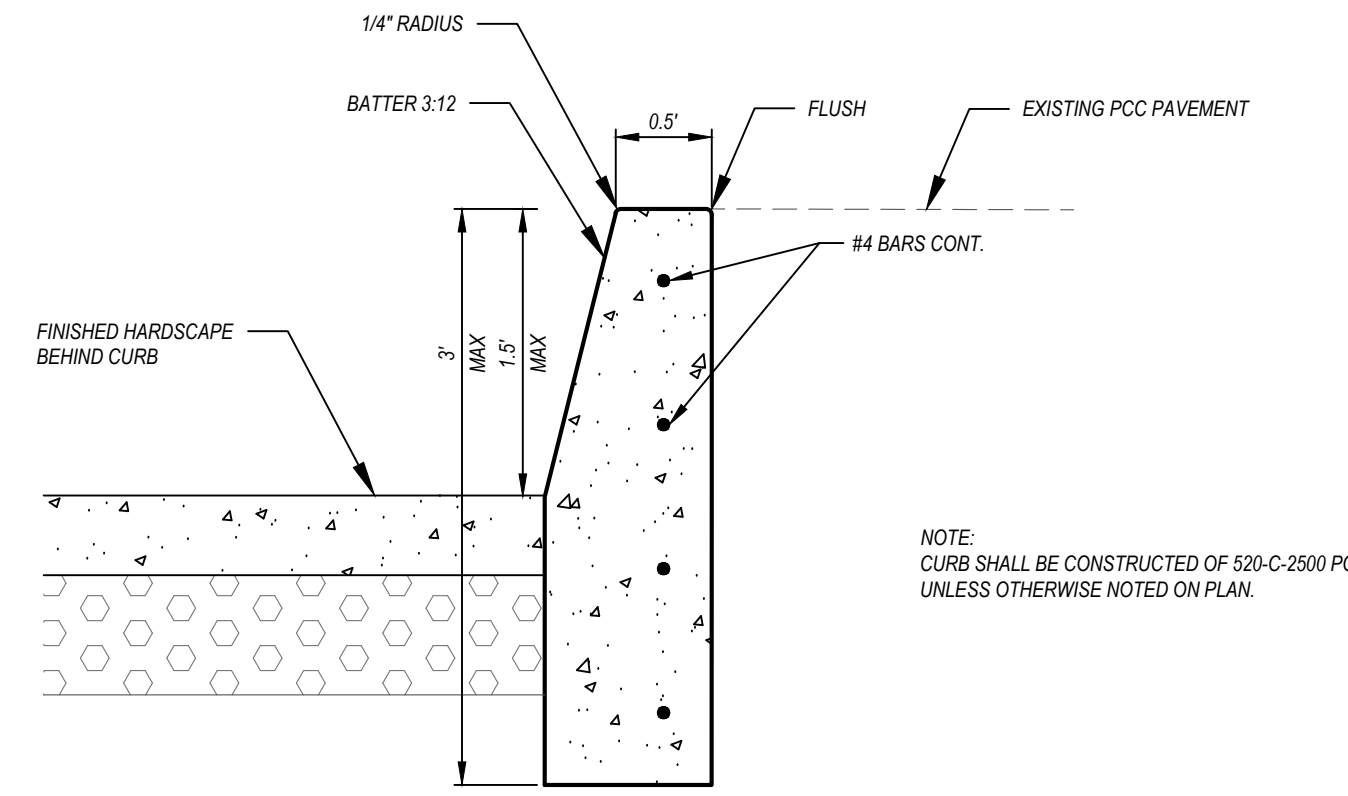

DETAIL "G" MODIFIED CURB

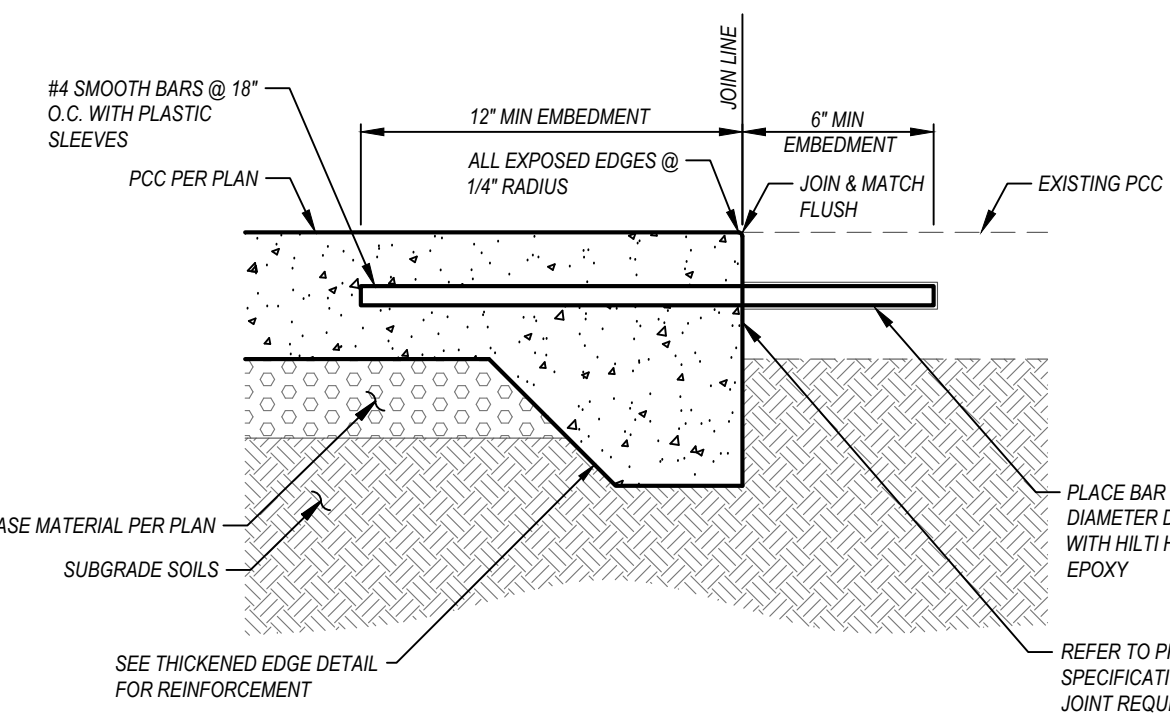

DETAIL "A" JOINT & MATCH ASPHALT

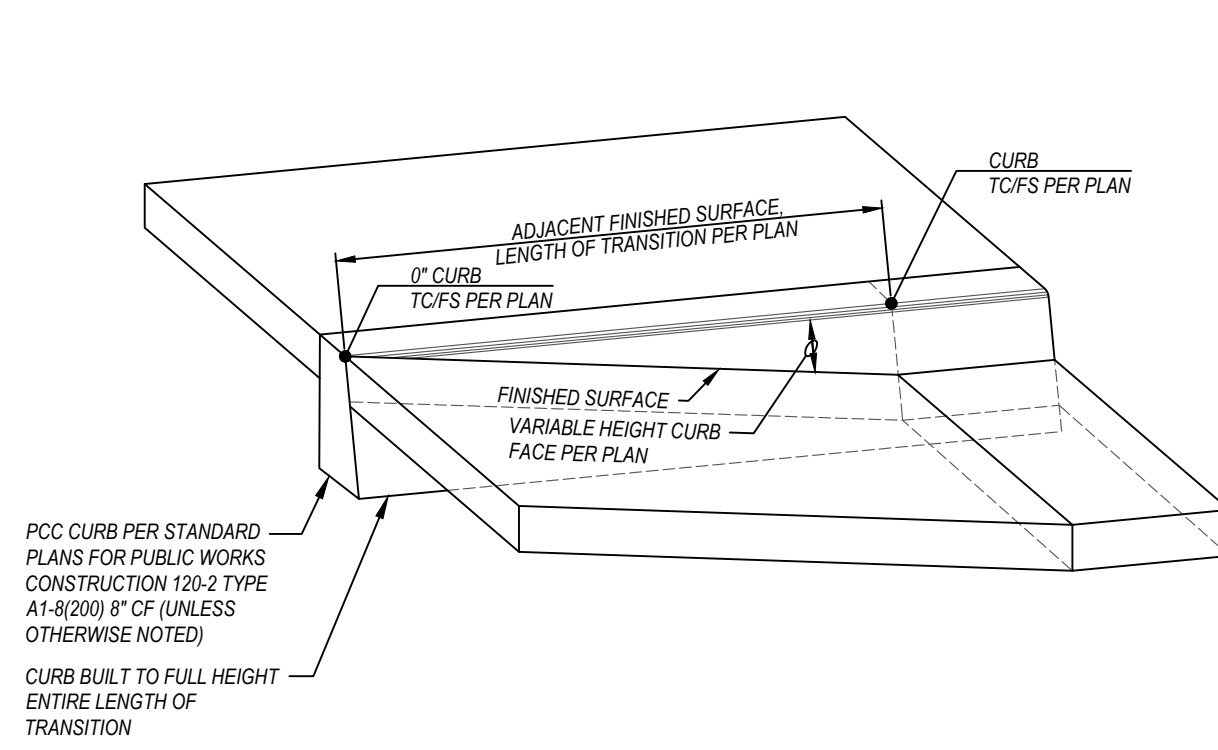

DETAIL "D" CURB TRANSITION

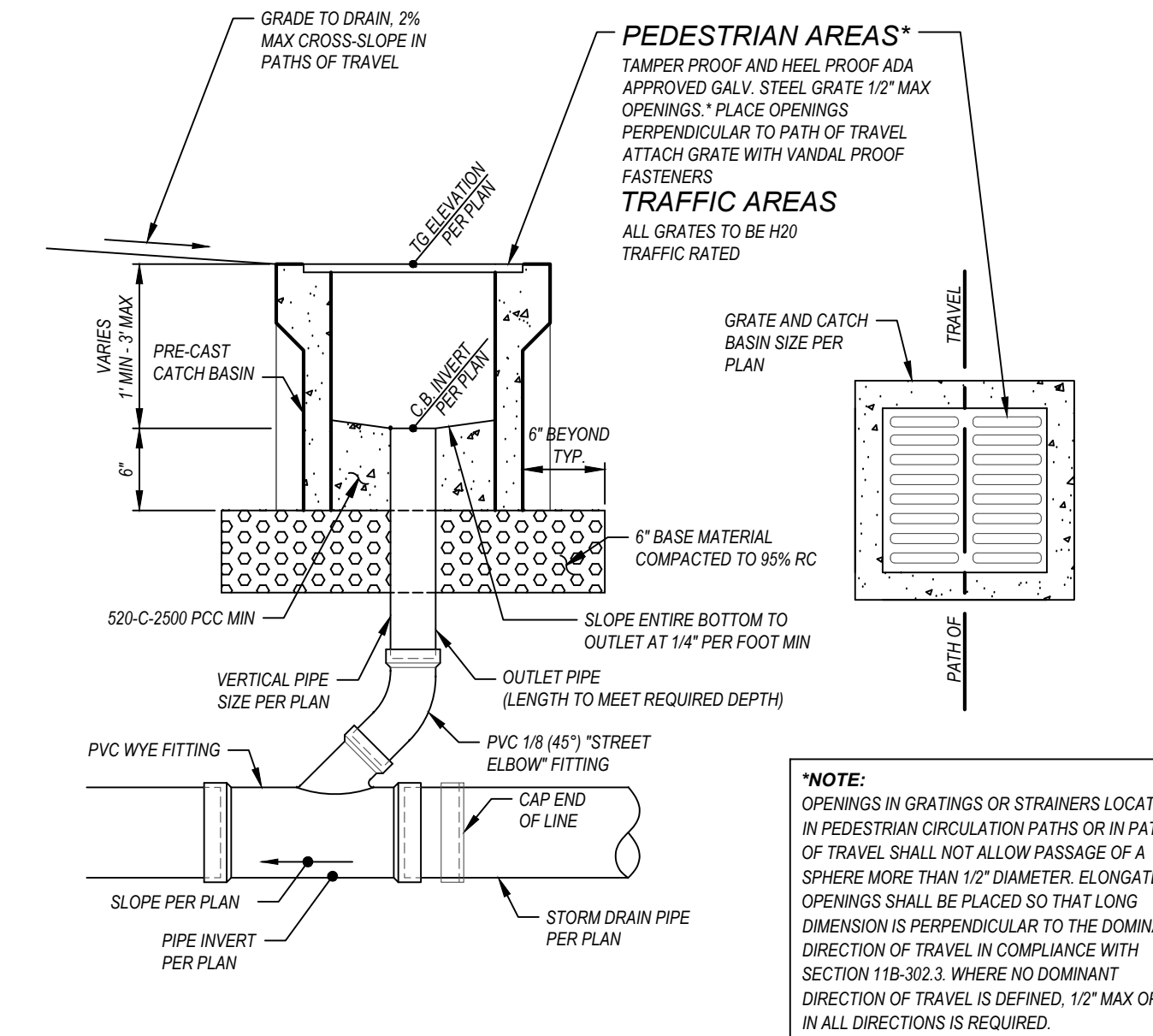

DETAIL "H" PRECAST PCC CATCH BASINS

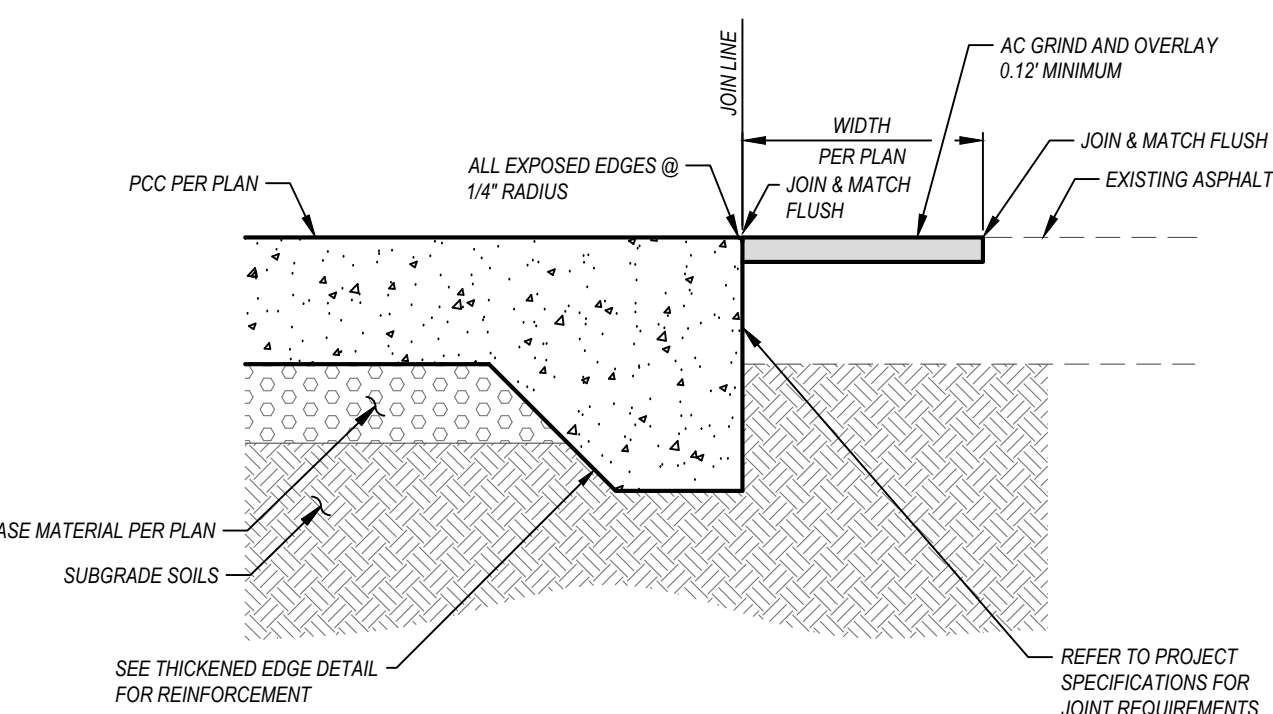

DETAIL "B" PCC WITH THICKENED EDGE

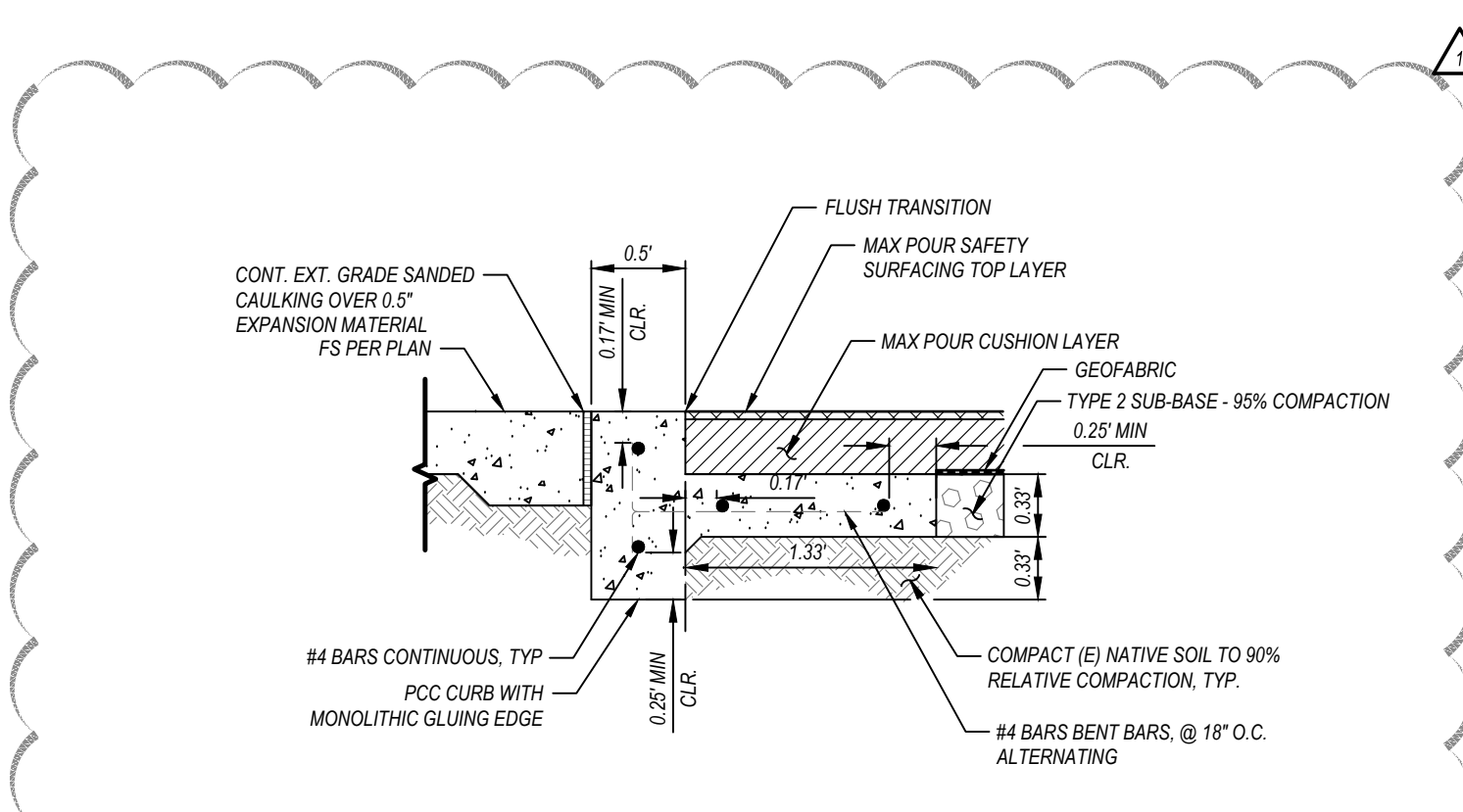

DETAIL "E" FLUSH CURB CONDITION

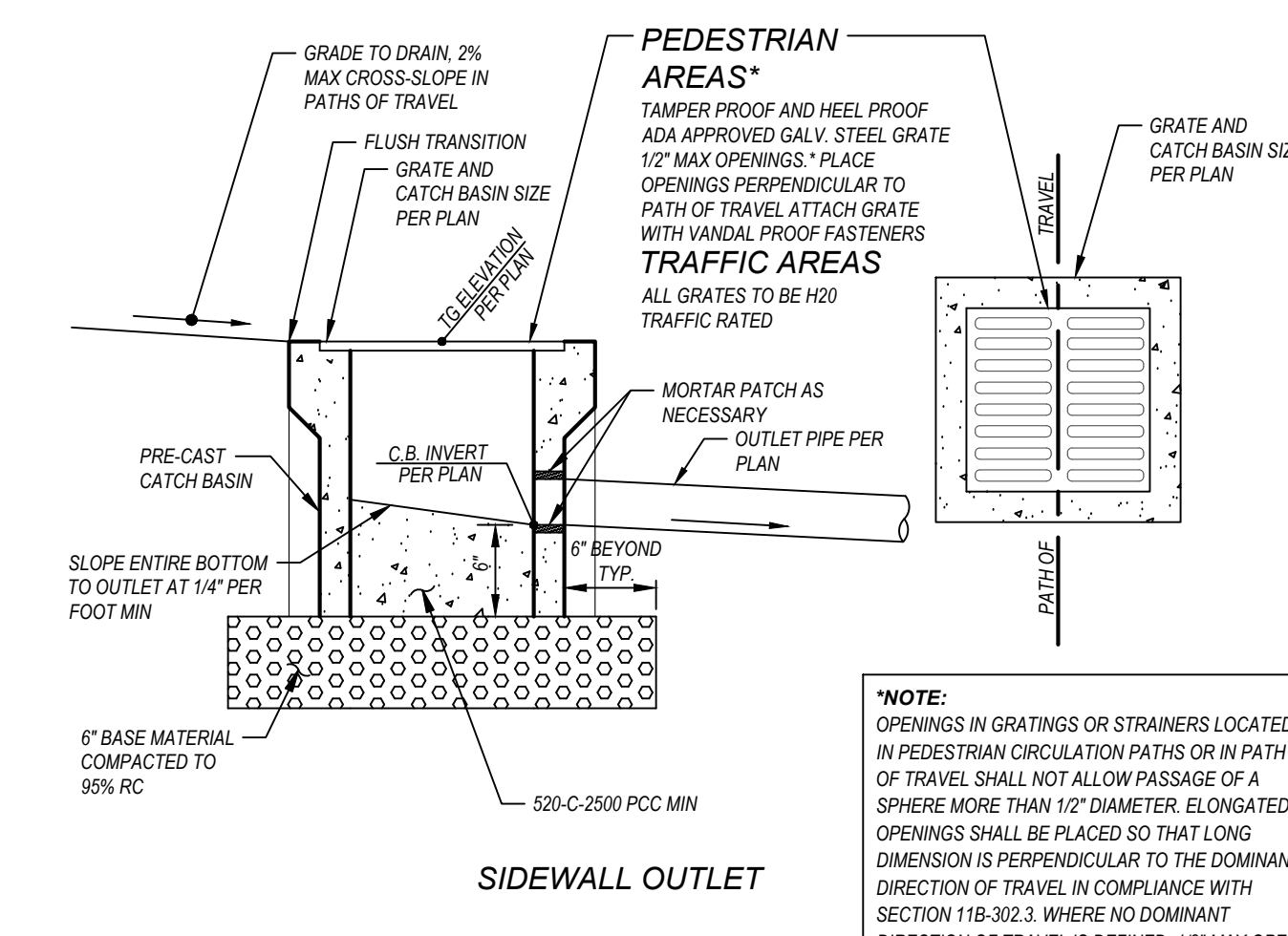

DETAIL "I" STORM DRAIN BUBBLER

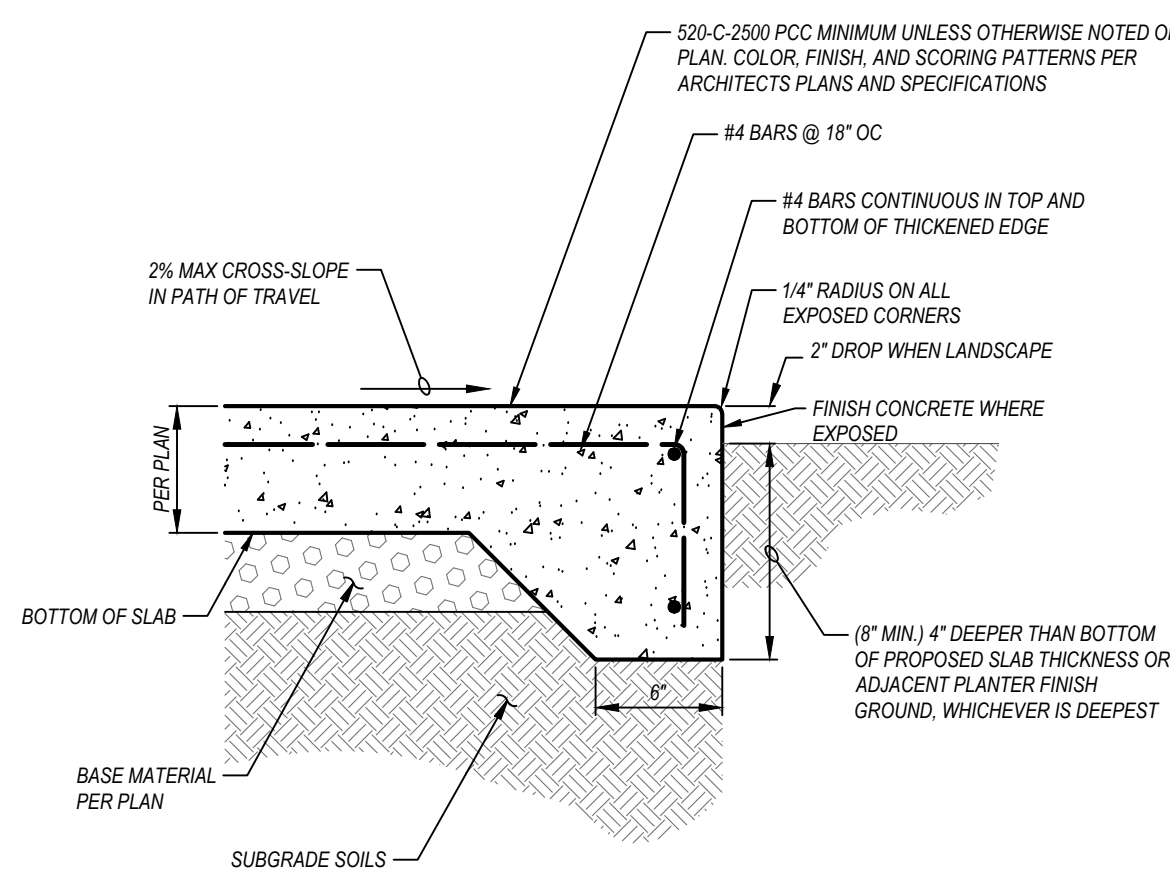

DETAIL "F" 0" PCC CURB

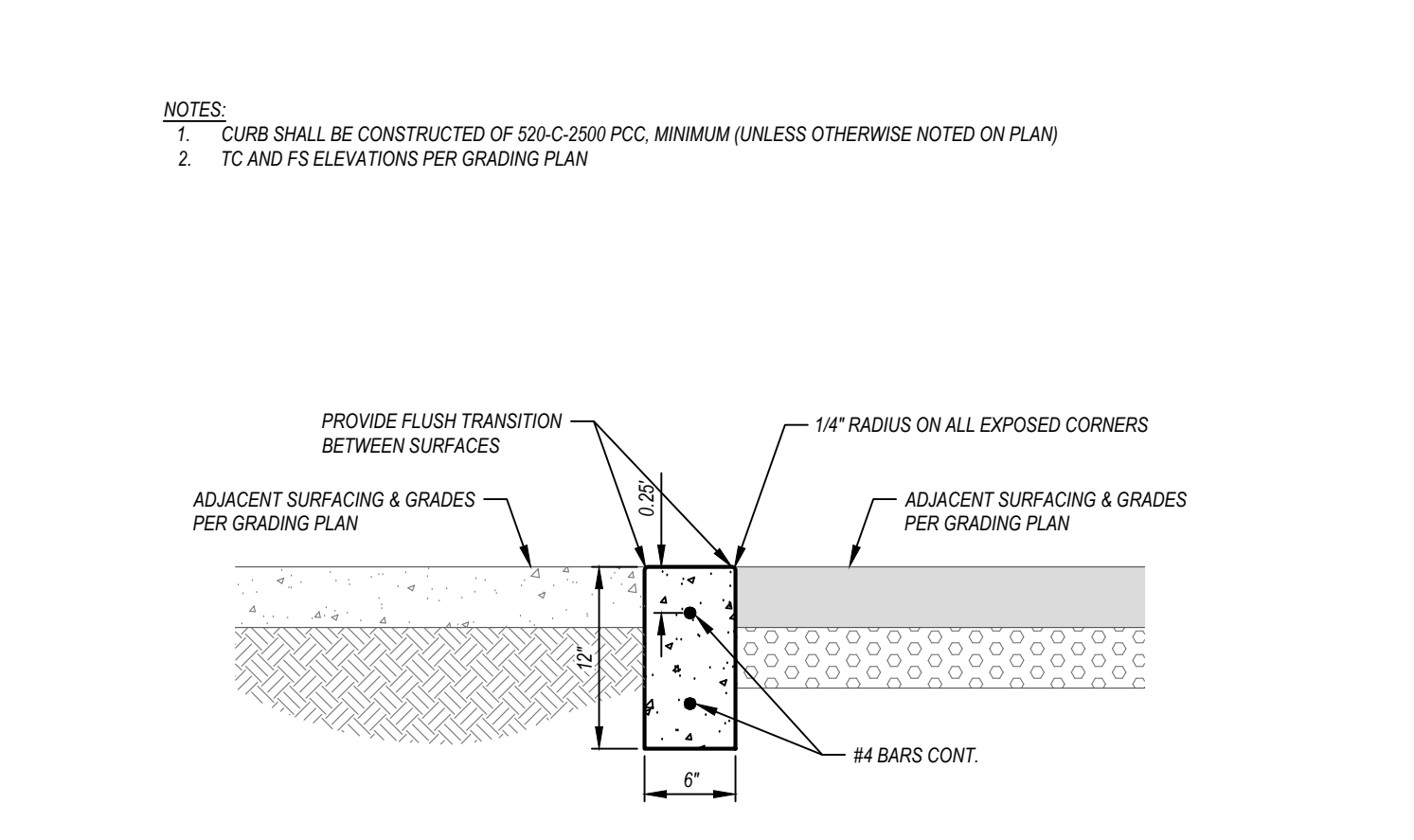

DETAIL "J" PVC PIPE CLEANOUT

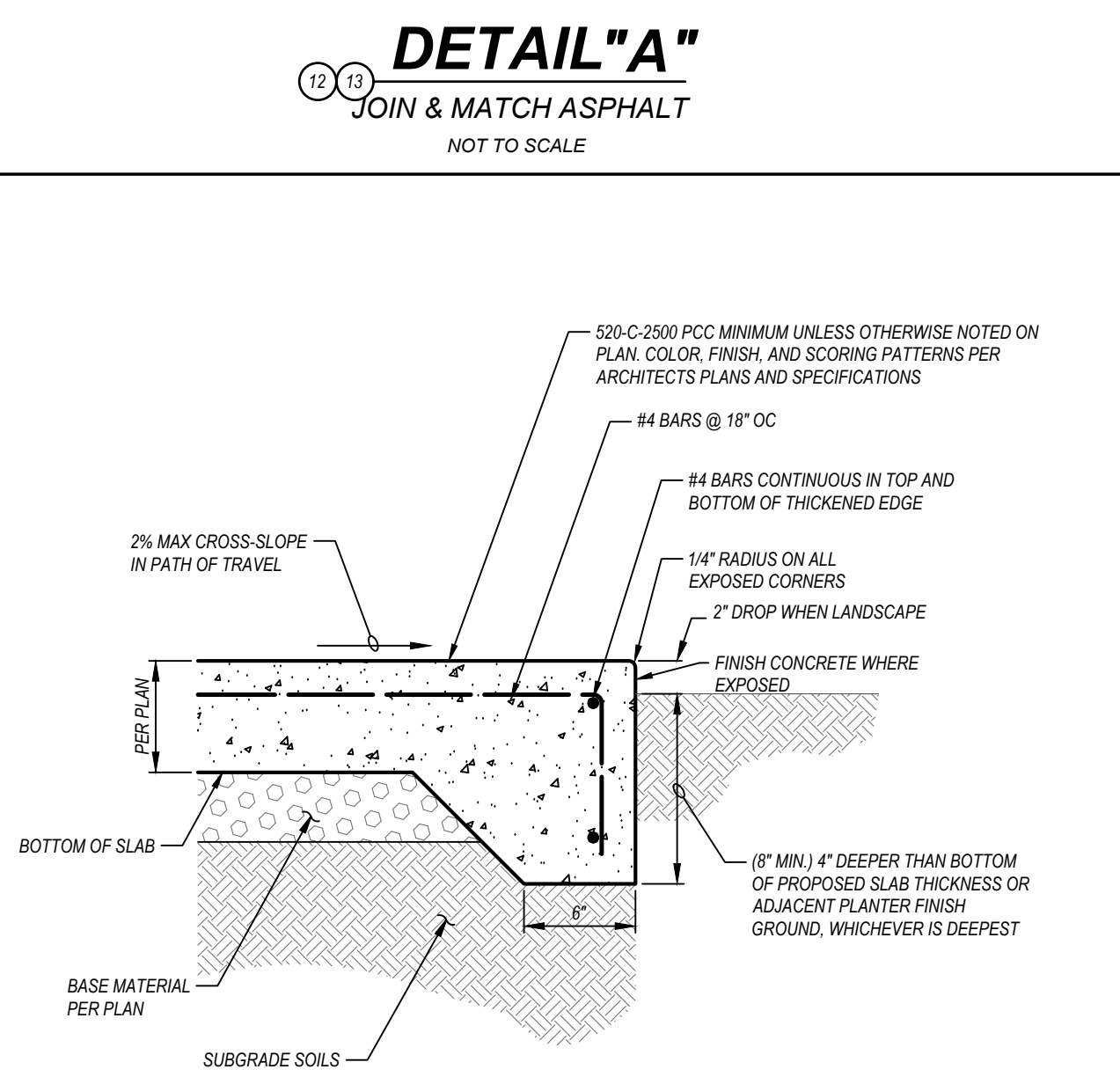

DETAIL "K" SLEEVE ELEVATION

DETAIL "B" PCC WITH THICKENED EDGE

GRADING CONSTRUCTION NOTES

- 10 PROTECT IN PLACE EXISTING ITEM
11 ADJUST EXISTING ITEM TO PROPOSED FINISHED GRADE
12 JOIN PROPOSED SURFACE TO EXISTING SURFACE PER DETAIL "A" ON SHEET C-5.1 WITH FLUSH TRANSITION, MATCH GRADE, DOWELING FOR PCC ONLY.

UTILITY CONSTRUCTION NOTES

- 13 FURNISH & INSTALL ALL PIPING PER UTILITY TABLES ON SHEET C-3.1
14 STORM DRAIN
15 FURNISH & INSTALL 12" X 12" X 12" PREFABRICATED CATCH BASIN (ASR CB1212 OR APPROVED EQUAL) PER DETAIL "H" ON SHEET C-5.1

TRAFFIC AREAS

- 16 OPENINGS IN GRATINGS OR STRAINERS LOCATED IN PEDESTRIAN CIRCULATION PATHS OR IN PATH OF TRAVEL SHALL NOT ALLOW PASSAGE OF A SPHERE MORE THAN 1/2" DIAMETER.

CLEANOUT IN GRASSY AREAS

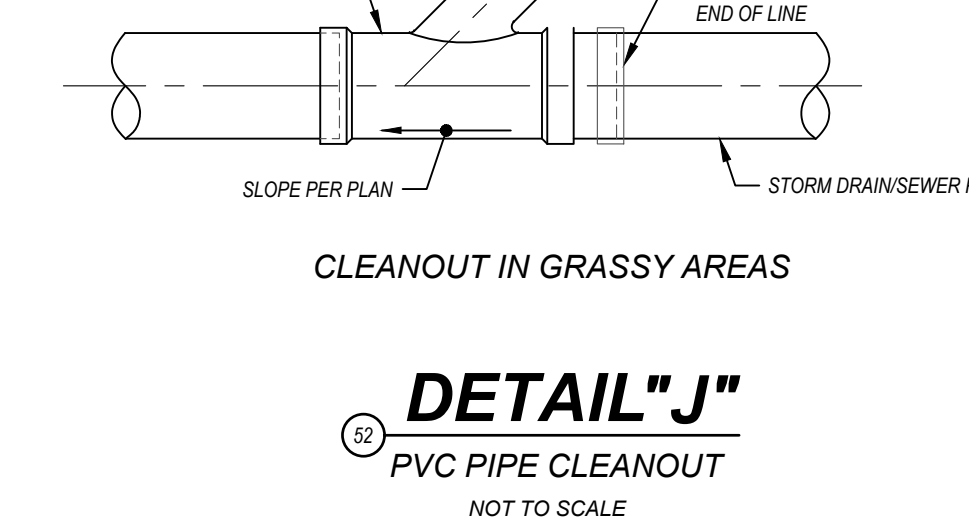

PEDESTRIAN AREAS

- 17 TAMPER PROOF AND HEEL PROOF ADA APPROVED GALV. STEEL GRATE 1/2" MAX OPENINGS - PLACE OPENINGS PERPENDICULAR TO PATH OF TRAVEL.

TRAFFIC AREAS

- 18 ALL GRATINGS TO BE HD3 TRAFFIC RATED

PEDESTRIAN AREAS

- 19 TAMPER PROOF AND HEEL PROOF ADA APPROVED GALV. STEEL GRATE 1/2" MAX OPENINGS - PLACE OPENINGS PERPENDICULAR TO PATH OF TRAVEL.

TRAFFIC AREAS

- 20 ALL GRATINGS TO BE HD3 TRAFFIC RATED

PEDESTRIAN AREAS

- 21 TAMPER PROOF AND HEEL PROOF ADA APPROVED GALV. STEEL GRATE 1/2" MAX OPENINGS - PLACE OPENINGS PERPENDICULAR TO PATH OF TRAVEL.

TRAFFIC AREAS

- 22 ALL GRATINGS TO BE HD3 TRAFFIC RATED

PEDESTRIAN AREAS

- 23 TAMPER PROOF AND HEEL PROOF ADA APPROVED GALV. STEEL GRATE 1/2" MAX OPENINGS - PLACE OPENINGS PERPENDICULAR TO PATH OF TRAVEL.

TRAFFIC AREAS

- 24 ALL GRATINGS TO BE HD3 TRAFFIC RATED

PEDESTRIAN AREAS

- 25 TAMPER PROOF AND HEEL PROOF ADA APPROVED GALV. STEEL GRATE 1/2" MAX OPENINGS - PLACE OPENINGS PERPENDICULAR TO PATH OF TRAVEL.

TRAFFIC AREAS

- 26 ALL GRATINGS TO BE HD3 TRAFFIC RATED

PEDESTRIAN AREAS

- 27 TAMPER PROOF AND HEEL PROOF ADA APPROVED GALV. STEEL GRATE 1/2" MAX OPENINGS - PLACE OPENINGS PERPENDICULAR TO PATH OF TRAVEL.

TRAFFIC AREAS

- 28 ALL GRATINGS TO BE HD3 TRAFFIC RATED

APPROVAL
ARCHITECT STAMP
CONSULTANT STAMP
CONSULTANT LOGO
EPIC ENGINEERS

PLAYGROUND ENHANCEMENTS @ GERALD A. SMITH ELEMENTARY SCHOOL

NO. DATE ISSUE
PROJECT NO.
DRAWN BY CHECKED BY
DATE
DRAWING TITLE
DETAIL SHEET
C-5.1

COLTON JOINT UNIFIED SCHOOL DISTRICT





# SpectraTurf

an ecore company

## *Playground Protective Surfacing Submittal*

NO EXCEPTION TAKEN  
 REJECTED/RESUBMIT

MAKE CORRECTIONS NOTED  
 REVISE AND RESUBMIT

REVIEW OF THESE SHOP DRAWINGS IS ONLY FOR GENERAL CONFORMANCE WITH THE DESIGN CONCEPT OF THE PROJECT AND GENERAL COMPLIANCE WITH THE INFORMATION GIVEN IN THE CONTRACT DOCUMENTS. ANY ACTION SHOWN IS SUBJECT TO THE REQUIREMENTS OF THE PLANS AND SPECIFICATIONS. CONTRACTOR IS RESPONSIBLE FOR DIMENSIONS WHICH SHALL BE CONFIRMED AND CORRELATED AT THE JOB SITE. FABRICATION PROCESSES AND TECHNIQUES OF CONSTRUCTION; COORDINATION OF HIS WORK WITH THAT OF OTHER TRADES AND THE SATISFACTORY PERFORMANCE OF HIS WORK.

**PCH ARCHITECTS**  
30 SOUTH CENTER STREET  
REDLANDS, CA 92373

BY Lis Zuloaga \_\_\_\_\_ DATE 2/7/24 \_\_\_\_\_



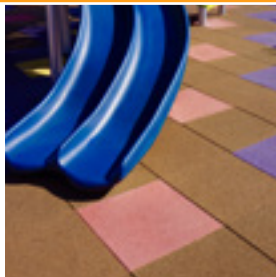

**Advancing Fun Play  
& Healthy Recreation  
for Every Age and All  
Abilities.**



## SpectraPour: Pour-in-Place Rubber Playground Surfacing



**SpectraPour** safety playground surfacing has been our flagship poured-in-place system since its inception in 1986. SpectraPour has been used on thousands of projects throughout the US at parks, schools, daycare centers, and other applications requiring a high quality, poured rubber safety surface.

SpectraPour's pour-in-place installation and wide variety of colors allows us to create intricate and visually pleasing designs. This enhances any gathering space – hotel play areas, playgrounds, shopping centers, community centers – into a welcoming and friendly location. SpectraPour's shock-absorbing qualities make it ideal for safety surfaces at critical fall heights as well as comfortable for any walking or standing application.

SpectraPour is mixed on-site, and may be used to provide ADA access to existing playgrounds, to retrofit existing play areas, or to fill entire new playgrounds with quality rubber surfacing that stays in place during use.

### SpectraPour System Data

- 2-layer system – mixed, poured & troweled on-site
  - Base layer of shock-absorbing rubber material
  - Half-inch-thick wearing surface of rubber granules
- Available in 20 colors (colors can be mixed)
- Create custom shapes and designs
- Porous system may be installed over Type 2 road base, concrete, or asphalt surfaces
- Typically used outdoors
- Conforms to ADA requirements
- IPEMA Certified
  - ASTM F1292 for head impact protection
  - ASTM F1951 for wheelchair accessibility
- Available for LEED® credits

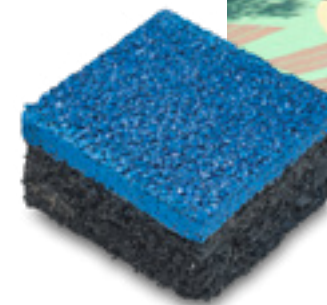





**IPEMA ASTM F1292-13 (SECTION 4.2) CERTIFICATE OF COMPLIANCE**

**ISSUE DATE:** December 18, 2017

**Requested By:** Alex Stout

**Project:** Sample

In the interest of public playground safety, IPEMA provides a third party certification service whereby TÜV SÜD America validates a manufacturer's certification of conformance to ASTM F1292 13 Standard Specification for Impact Attenuation of Surfacing Materials Within the Use Zone of Playground Equipment Standard, Section 4.2, Performance Criterion.

The manufacturers listed below have received written validation from TÜV SÜD America that the products listed conform with the requirements of ASTM F1292-13, Section 4.2.

The validation is made by testing at the specified fall height rating requested by the manufacturer, based upon its experience and knowledge of its products, instead of the "critical fall height" used in ASTM F1292 13. TÜV SÜD America validates that the impact attenuating performance criterion specified by ASTM F1292 13 (Section 4.2) has been met or exceeded.

PRODUCT	PRODUCT LINE	THK/HT	MANUFACTURER	DESCRIPTION
SP5	SpectraPour Safety Surfacing	2" / 5'	SpectraTurf	SpectraPour
SP6	SpectraPour Safety Surfacing	2.5" / 6'	SpectraTurf	SpectraPour
SP7	SpectraPour Safety Surfacing	3" / 7'	SpectraTurf	SpectraPour
SP8	SpectraPour Safety Surfacing	3.5" / 8'	SpectraTurf	SpectraPour
SP10	SpectraPour Safety Surfacing	4.25" / 10'	SpectraTurf	SpectraPour
SP12	SpectraPour Safety Surfacing	5" / 12'	SpectraTurf	SpectraPour

## SPECTRATURF COLOR CHART

AVAILABLE IN 1-4mm & 0.5-1.5mm GRANULE SIZES

### Standard Colors



Standard  
Red



Standard  
Green



Standard  
Blue



Beige



Black

### Premium Colors

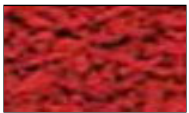

Bright  
Red



Bright  
Green



Light / Sky  
Blue

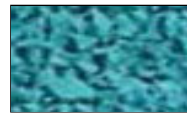

Turquoise /  
Teal

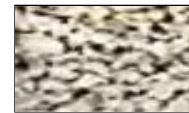

Cream /  
Eggshell



Brown



Bright  
Yellow

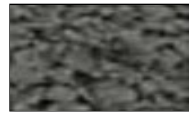

Dark Gray /  
Charcoal

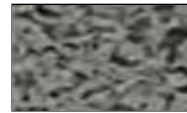

Medium  
Gray

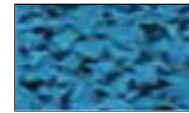

Azure

### Custom Colors

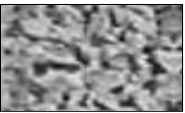

Light / Pale  
Gray

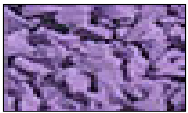

Light  
Purple

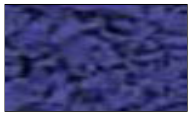

Dark  
Purple



Earth Yellow /  
Mustard



Orange

Colors may differ slightly from above due to photo reproduction process.

All 0.5-1.5 Granule Size's must use Aliphatic Binder. Aliphatic binder HIGHLY recommended for all Premium and Custom Colors in 1-4mm Granule Size.

All Premium & Custom Colors have additional costs and potential lead times of 8-12 weeks

Custom Colors may have minimum order requirements



# SpectraPour Binder

## Product Data Sheet



**SpectraPour Binder** is a high-performance 100% solids, aromatic, single component, moisture-curing, MDI based prepolymer polyurethane resin binder designed for use with rubber granules. It is specifically designed for application of poured-in-place playground and other sports surfacing using appropriate recycled rubber and EPDM granules. SpectraPour Binder does not support fungal growth.

**SpectraPour Binder** requires surface and ambient temperatures must be at least 45 deg. F. Do not apply over wet or damp surface. Do not mix or apply when rain is imminent or falling. Substrate must be free of dust, oil and grease. Ambient temperature and relative humidity are critical to product reaction. Consult SpectraTurf whenever conditions of very high or very low temperatures and/or very high or low relative humidity are present of anticipated.

### Specifications

Appearance	Amber	Visual	Free NCO Content	7.5 / 8.5%
Density	approx. 1.1 g.cm <sup>3</sup> @ 20 degrees C		% Solids by weight	>99%
Viscosity, 25 deg. C	approx. 2,000 / 2,300		PH value	n/a
Setting point	-18 degrees C		Evaporation Rate	Not applicable
Initial Boiling Point	260 degrees		Vapor Density	(Air=1) Heavier than air
Solubility in water	Reacts		Explosive limits	n/a
Flash point	> 200 degrees C		Thermal decomposition	n/a
Flammability limits in air by volume	Lower - n/a	Upper - n/a	Specific Gravity	(H2O = 1) 1.00-1.102

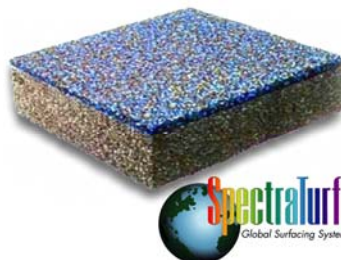

# PIP 048 BUFFINGS



1 (951) 214-6590

## PRODUCT DESCRIPTION

### Description

**PIP 048 BUFFINGS** are used in the construction of the cushion layer in unitary safety surfacing systems as well as the bottom layer in factory molded rubber safety tiles.

**PIP 048 BUFFINGS** are produced through a state of the art recycling process that removes contaminants and produces a mixture of controlled sizes that are ideal for field manufactured poured in place rubber surfacing as well as compression molded rubber tiles produced in a factory environment.

### Benefits

- ✓ **Non Toxic:** Certified Safe by UC Berkeley and The Corporation for Manufacturing Excellence
- ✓ **Environmentally Friendly:** reduces the number of waste tires disposed in land fills
- ✓ **Locally Produced:** Reduces green house gas emissions through reduced transportation and reduces freight costs.
- ✓ **Quality:** Consistent quality delivered through state of art recycling process backed by an industry leader with more than 20 years experience.

### Packaging

50LB Bags or 2,000LB Sacks

### Physical Characteristics

CHEMICAL PROPERTIES	MIN	MAX
Acetone Extract	12	22
Ash	0	8
Carbon Black	26	35
Rubber Hydrocarbon	45	60

SIEVE SIZE	% RETAINED
1/4"	0% - 2%
8 Mesh	30% - 60%
16 Mesh	60% - 95%
20 Mesh	75% - 100%
30 Mesh	98% - 100%

- Test Method 100 grams, 10 minutes, Rotap Shaker

- Values "typical", custom blends available to meet any specification requirement.





## MAINTENANCE GUIDELINES

Addendum A (1 of 2)

The following maintenance guidelines are hereby noted as an attachment to the SpectraTurf Statement of Warranty and are so noted in the report of Warranty as Addendum A.

SpectraTurf is under no obligation to repair or replace any of its Playground safety Surfacing Systems that are damaged by improper maintenance; vandalism; product misuse, abuse or alteration; improper drainage; normal wear and tear; damage from sharp objects; unapproved cleaning materials; or Acts of God.

### **Recommended Monthly Maintenance:**

1. Power Wash the entire Playground Safety Surfacing to remove surface dirt, food, drink, sand, and various contaminants. Use an air blower to remove loose debris before Power Washing the Playground Safety Surface.
2. On heavily stained isolated areas, after wetting, apply a sufficient amount of all-purpose cleaner and scrub with a 10" minimum bristle brush. Rinse thoroughly and repeat as necessary. Perform hand cleaning early in the morning or late afternoon so that the cleanser will have time to work before evaporating in high temperature conditions.
3. Power Washing can be performed any time during the day. Please refer to Addendum A (2 of 2) for illustrated procedures for power washing the Playground Safety Surfacing.

### **Other Recommended Maintenance:**

1. Every 2 to 3 years, depending upon the amount of use the play area receives, an application (roll coat) of aliphatic resin should be applied to the Playground Safety Surfacing. Aliphatic resin should be applied by rollers (NOT air sprayers) at a rate of approx. 60 sq ft per gallon over the entire wear layer of the Playground Safety Surfacing and allowed to cure for a minimum 72 hours before use of the play area.

**NEVER USE A STEEL OR HARD PLASTIC BRUSH ON MANUAL OR ELECTRIC CLEANING UNITS. CONSULT WITH SPECTRATURF AT (800) 875-5788 BEFORE COMMENCING ANY CLEANING OPERATION THAT MAY BE HARMFUL TO THE PLAYGROUND SURFACING SYSTEM**





# MAINTENANCE GUIDELINES

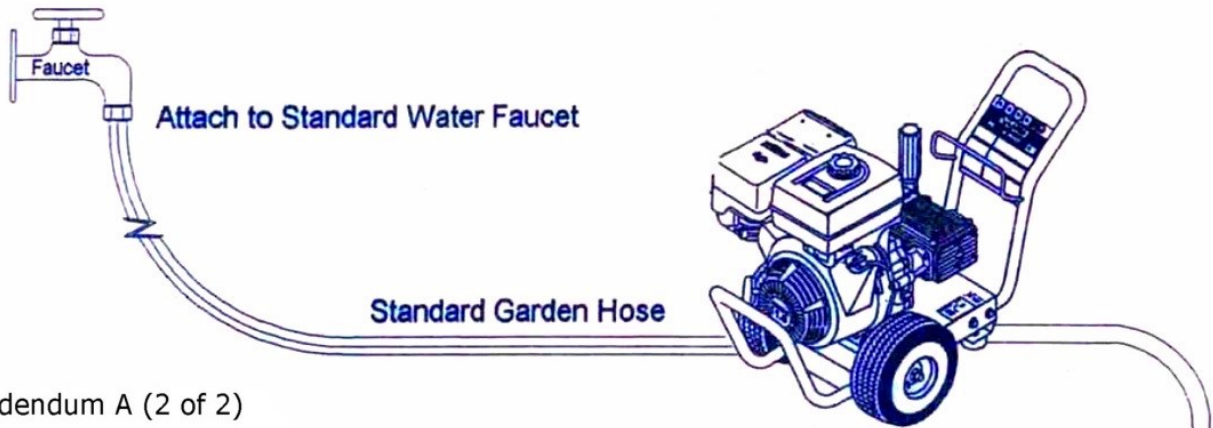

Addendum A (2 of 2)

The use of the Power Washer is a simple procedure.

## POWER WASHER

- 1) Use a Power Washer with pressure set at 1500 PSI.
- 2) Connect the Power Washer to a water faucet outlet.
- 3) Use a Power Washer Nozzle with a 24/1000" orifice.
- 4) Turn on Power Washer and test pressure and spray pattern on a hard surface (i.e. cement) to gauge distance and impact of water spray.
- 5) Hold spray nozzle approximately 10 inches from surface being cleaned. for best results, spray on a slight angle between 45 – 60 degrees.
- 6) Start at the center of the rubber surface installation and power clean towards the outer edges in a continuous back and forth motion.
- 7) As you proceed, check the surface to make sure you did not miss any areas of contamination.
- 8) Let the Playground Safety Surfacing completely dry before opening for play activity.

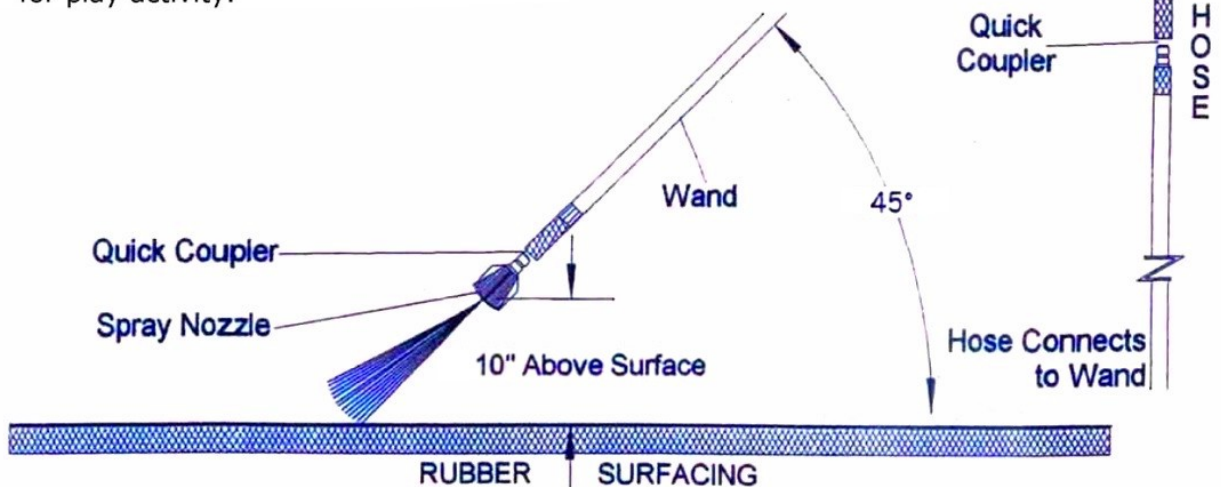



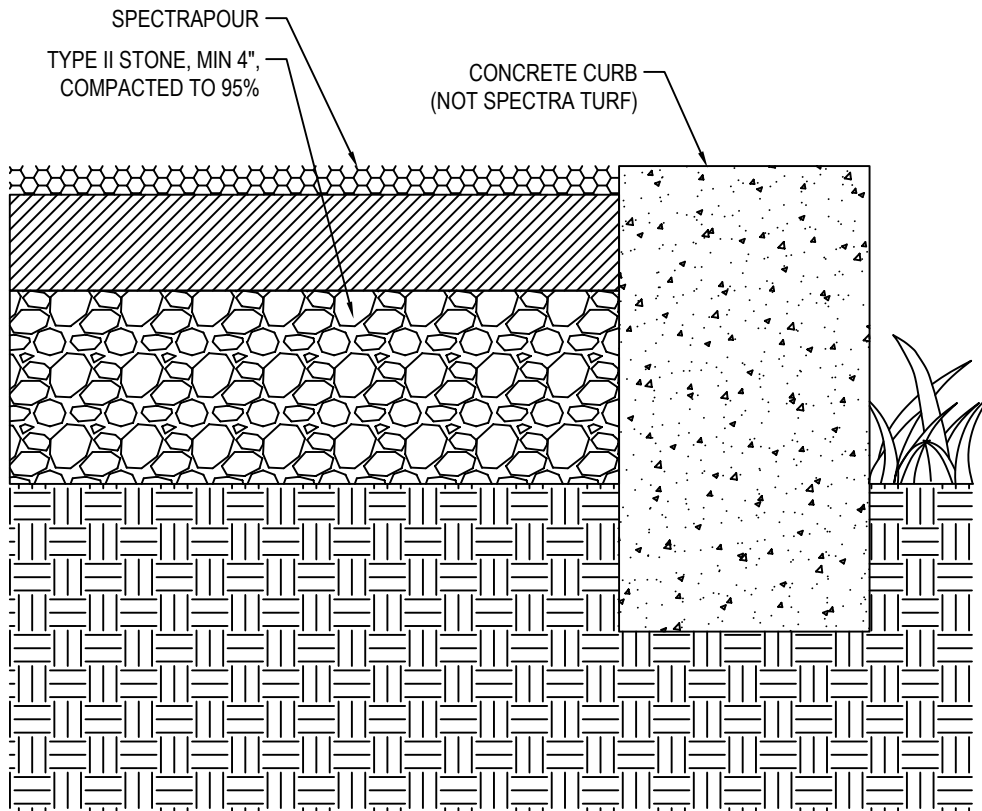

SECTION

NOTES:

1. INSTALLATION TO BE COMPLETED IN ACCORDANCE WITH MANUFACTURER'S SPECIFICATIONS.
2. DO NOT SCALE DRAWING.
3. THIS DRAWING IS INTENDED FOR USE BY ARCHITECTS, ENGINEERS, CONTRACTORS, CONSULTANTS AND DESIGN PROFESSIONALS FOR PLANNING PURPOSES ONLY. THIS DRAWING MAY NOT BE USED FOR CONSTRUCTION.
4. ALL INFORMATION CONTAINED HEREIN WAS CURRENT AT THE TIME OF DEVELOPMENT BUT MUST BE REVIEWED AND APPROVED BY THE PRODUCT MANUFACTURER TO BE CONSIDERED ACCURATE.
5. CONTRACTOR'S NOTE: FOR PRODUCT AND COMPANY INFORMATION VISIT [www.CADdetails.com/info](http://www.CADdetails.com/info) AND ENTER REFERENCE NUMBER 092-030

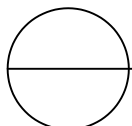

## SPECTRAPOUR POUR-IN-PLACE

SPECTRAPOUR: STANDARD CURB - FLUSH TO CONCRETE CURB OR WALL

# SpectraPour Poured-in-Place Specification

SpectraTurf  
555 South Promenade Avenue #103  
Corona, CA 92879  
Phone: (951) 736-3579  
Fax: (951) 734-3630  
E-mail: [info@spectraturf.com](mailto:info@spectraturf.com)  
[www.spectraturf.com](http://www.spectraturf.com)

## PART 1 GENERAL

### 1.01 SUMMARY

A. Section Includes: SpectraPour Poured-in-Place Playground Surfacing System.

**Specifier Note:** Revise paragraph below to suit project requirements. If a reader of this section could reasonably expect to find a product or component specified in this section, but it is actually specified elsewhere, then the related section number(s) should be listed in the paragraph below. In the absence of related sections, delete paragraph below.

**Specifier Note:** Site materials and methods, drainage, playground equipment, fencing, substrate preparation and similar work is provided by other contractors and is described in other sections. Consult manufacturer for specific substrate preparation requirements. Edit, retain or delete paragraph below to suit project requirements and specifier practice.

B. Related Sections: Sitework Sections: Materials and Methods, Excavation, Asphalt Paving, Concrete Paving, Sub-Drainage, Storm Drainage, Fencing, Playground Equipment and Structures.

**Specifier Note:** Article below may be omitted when specifying manufacturer's proprietary products and recommended installation. Retain References Article when specifying products and installation by an industry reference standard. If retained, list standard(s) referenced in this section. Indicate issuing authority name, acronym, standard designation and title. Establish policy for indicating edition date of standard referenced. Conditions of the Contract or Division 1 References Section may establish the edition date of standards. This article does not require compliance with standard. It is a listing of all references used in this section.

### 1.02 REFERENCES

A. American Society for Testing and Materials (ASTM):

1. ASTM D412 Standard Test Methods for Vulcanized Rubber and Thermoplastic Rubbers and Thermoplastic Elastomers-Tension.

2. ASTM D624 Standard Test Method for Tear Strength of Conventional Vulcanized Rubber and Thermoplastic Elastomers.
3. ASTM D2047 Standard Test Method for Static Coefficient of Friction of Polish-Coated Floor Surfaces as Measured by the James Machine.
4. ASTM D2859 Standard Test Method for Flammability of Finished Textile Floor Covering Materials.
5. ASTM E303 Standard Test Method for Measuring Surface Frictional Properties Using the British Pendulum Tester.
6. ASTM F1292 Standard Specification for Impact Attenuation of Surface Systems Under and Around Playground Equipment.
7. ASTM F1951 Standard Specification for Determination of Accessibility of Surface Systems Under and Around Playground Equipment.

**Specifier Note:** Article below should be restricted to statements describing design or performance requirements and functional (not dimensional) tolerances of a complete system. Limit descriptions to composite and operational properties required to link components of a system together and to interface with other systems.

### 1.03 SYSTEM DESCRIPTION

A. Performance Requirements: Provide a 2 layer rubber-urethane playground surfacing system which has been designed, manufactured and installed to meet the following criteria:

1. Shock Attenuation (ASTM F1292):
  - a. Gmax: Less than 200.
  - b. Head Injury Criteria: Less than 1000.
2. Flammability (ASTM D2859): Pass.
3. Tensile Strength (ASTM D412): 60 psi (413 kPa).
4. Tear Resistance (ASTM D624): 140%.
5. Water Permeability: 0.4 gal/yd<sup>2</sup>/second.
6. Accessibility: Comply with requirements of ASTM F1951.

FROM SPEC.

4. Permeability: Product shall meet or exceed a coefficient of permeability of seven (7) feet per minute. NOTE: From a geotechnical standpoint, the permeability of a material is a measure of the velocity at which water will flow through the void spaces or pores under a given hydraulic gradient. The

**Specifier Note:** Article below includes submittal of relevant data to be furnished by Contractor before, during or after construction. Coordinate this article with Architect's and Contractor's duties and responsibilities in Conditions of the Contract and Division 1 Submittal Procedures Section.

#### **1.04 SUBMITTALS**

A. General: Submit listed submittals in accordance with Conditions of the Contract and Division 1 Submittal Procedures Section.

B. Product Data: Submit manufacturer's product data and installation instructions.

C. Verification Samples: Submit manufacturer's standard verification samples of 6" x 6" minimum.

D. Quality Assurance/Control Submittals: Submit the following:

1. Certificate of qualifications of the playground surfacing installer.

E. Closeout Submittals: Submit the following:

1. Warranty documents specified herein.

**Specifier Note:** Article below should include statements of prerequisites, standards, limitations and criteria that establish an overall level of quality for products and workmanship for this section. Coordinate article below with Division 1 Quality Assurance Section.

#### **1.05 QUALITY ASSURANCE**

A. Qualifications: Utilize an installer approved and trained by the manufacturer of the playground surfacing system or a direct employee of the manufacturer's installation division, having experience with other projects of the scope and scale of the work described in this section.

B. Certifications: Certification by manufacturer that installer is an approved applicator of the playground surfacing system.

C. International Play Equipment Manufacturers Association (IPEMA) certified.

**Specifier Note:** Article below should include specific protection and environmental conditions required during storage. Coordinate article below with Division 1 Product Requirements Section.

## **1.06 DELIVERY, STORAGE & HANDLING**

A. General: Comply with Division 1 Product Requirement Section.

B. Delivery: Deliver materials in manufacturer's original, unopened, undamaged containers with identification labels intact.

C. Storage and Protection: Store materials protected from exposure to harmful environmental conditions and at a minimum temperature of 40 degrees F (4 degrees C) and a maximum temperature of 90 degrees F (32 degrees C).

**Specifier Note:** In article below, state physical or environmental limitations or criteria for installation such as weather, temperature, humidity, ventilation or illumination required for proper installation or application.

## **1.07 PROJECT/SITE CONDITIONS**

A. Environmental Requirements: Install surfacing system when minimum ambient temperature is 40 degrees F (1 degree C) and maximum ambient temperature is 95 degrees F (32 degrees C). Exception to the temperature requirements can be made by the manufacturer of the surfacing system. Do not install in steady or heavy rain.

**Specifier Note:** Coordinate article below with Conditions of the Contract and with Division 1 Closeout Submittals (Warranty) Section. Use this article to require special or extended warranty or bond covering the work of this section.

## **1.08 WARRANTY**

A. Project Warranty: Refer to Conditions of the Contract for project warranty provisions.

B. Proper drainage is critical to the longevity of the SpectraPour Poured-in-Place surfacing system. Inadequate drainage will cause premature breakdown of the poured system in affected areas; and void the warranty.

**Specifier Note:** Coordinate subparagraph below with manufacturer's warranty requirements.

1. Warranty Period: Five (5) years from date of completion of work.

# PART 2 PRODUCTS

**Specifier Note:** Retain article below for proprietary method specification. Add product attributes, performance characteristics, material standards and descriptions as applicable. Use of such phrases as "or equal" or "or approved equal" or similar phrases may cause ambiguity in specifications. Such phrases require verification (procedural, legal and regulatory) and assignment of responsibility for determining "or equal" products.

## 2.01 SPECTRAPOUR PLAYGROUND SURFACING SYSTEM

**Specifier Note:** Retain or delete paragraph below per project requirements and specifier's practice.

A. Manufacturer: SpectraTurf, Inc.

1. Contact: 555 South Promenade Avenue, #103, Corona, CA 92879;  
Telephone: (800) 875-5788; Fax: (951) 734-3630;  
E-mail: [info@spectraturf.com](mailto:info@spectraturf.com) website: <http://www.spectraturf.com>.

B. Proprietary Products/Systems. SpectraPour Poured-in-place playground surfacing system, including the following:

1. SpectraPour Poured-In-Place Primer:

a. Material: Urethane.

2. SpectraPour Poured-in-Place Basemat:

a. Material: 100% recycled blend of shredded SBR (styrene butadiene rubber) and urethane.

**Specifier Note:** The type of playground equipment determines the required basemat thickness, and the basemat thickness may be different at various locations on the playground site. Depending on ASTM F1292 requirements for critical fall height (4', 5', 6', 7', 8', 10', or 12'), select basemat thickness from options provided in subparagraph below (1-1/4", 1-1/2", 2", 2 1/2", 3", 4" or 4 1/2" respectively). Specify project requirements below and coordinate with working drawings.

b. Basemat Thickness: [1 1/4"] [1 1/2"] [2"] [2 1/2"] [3"] [4"] [4 1/2"]

3. SpectraPour Poured-In-Place Top Surface:

a. Material: Blend of recycled EPDM (ethylene propylene diene monomer) rubber and aromatic or aliphatic urethane binder.

b. Top Surface Thickness: minimum 1/2", maximum 5/8".



c. Color: [Terra Cotta] [Bright Red] [Orange] [Bright Yellow] [Earth Yellow] [Beige] [Sand] [Eggshell] [Brown] [Bright Green] [Army Green] [Green] [Teal] [Sky Blue] [Blue] [Light Purple] [Dark Purple] [Gray] [Charcoal] [Black] [Custom color mix (specify requirements)].

**Specifier Note:** Aliphatic urethane is recommended for the following colors: Bright Yellow, Bright Green, Teal, Bright Red, Orange, Light Purple, Dark Purple, Sky Blue, Sand & Eggshell. Standard aromatic binder “yellows” slightly upon exposure to ultraviolet rays. Most of this thin layer of urethane wears off with foot traffic and weathering typically within two to six months. *This characteristic applies industry-wide.*

**Specifier Note:** The following colors are recommended for indoor use only due to their high tendency for fading: Bright Yellow, Bright Red, Orange, Light Purple, Dark Purple.

d. Dry Static Coefficient of Friction (ASTM D2047): 1.0.

e. Wet Static Coefficient of Friction (ASTM D2047): 0.9.

f. Dry Skid Resistance (ASTM E303): 89.

g. Wet Skid Resistance (ASTM E303): 57.

**Specifier Note:** Edit Article below to suit project requirements. If substitutions are permitted, edit text below. Add text to refer to Division 1 Project Requirements (Product Substitutions Procedures) Section.

## 2.02 PRODUCT SUBSTITUTIONS

A. Substitutions: No substitutions permitted.

**Specifier Note:** Specify proportions and procedures for site mixing materials. Mixing is the preparation of materials for use and is considered to be part of the manufacturing process.

## 2.03 MIXES

A. Required mix proportions by weight:

1. Basemat: 16+% urethane (as ratio: 14% urethane divided by 86% rubber). 14% urethane, 86% rubber (based on entire rubber & urethane mix).

2. Top Surface: 22% urethane (ratio: 18% urethane divided by 82% rubber). 18% urethane, 82% rubber (based on entire rubber & urethane mix).

# PART 3 EXECUTION

**Specifier Note:** Revise article below to suit project requirements and specifier's practice.

## 3.01 MANUFACTURER'S INSTRUCTIONS

A. Comply with the instructions and recommendations of the playground surfacing manufacturer.

**Specifier Note:** Specify actions to physically determine that conditions are acceptable to receive primary products of the section.

## 3.02 EXAMINATION

A. Substrate preparation must be in accordance with surfacing manufacturer's specification. New asphalt must be fully cured – up to 30 days. New concrete must be fully cured – up to 7 days.

B. Proper drainage is critical to the longevity of the SpectraPour CA Poured-in-Place surfacing system. Inadequate drainage will cause premature breakdown of the poured system in affected areas; and void the warranty.

**Specifier Note:** Specify actions required to physically prepare the surface, area, or site or to incorporate the primary products of the section.

## 3.03 PREPARATION

A. Surface Preparation: Using a brush or short nap roller, apply primer to the substrate perimeter and any adjacent vertical barriers such as playground equipment support legs, curbs or slabs that will contact the surfacing system at the rate of 300 ft<sup>2</sup>/gal.

**Specifier Note:** Coordinate article below with manufacturer's recommended installation requirements.

## 3.04 INSTALLATION

A. Do not proceed with playground surfacing installation until all applicable site work, including substrate preparation, fencing, playground equipment installation and other relevant work, has been completed.

B. Basemat Installation:

1. Using screeds and hand trowels, install the basemat at a consistent density of 29 pounds, 1 ounce per cubic foot to the specified thickness.

2. Allow basemat to cure for sufficient time so that indentations are not left in the basemat from applicator foot traffic or equipment.

3. Do not allow foot traffic or use of the basemat surface until it is sufficiently cured.

C. Primer Application: Using a brush or short nap roller, apply primer to the basemat perimeter and any adjacent vertical barriers such as playground equipment support legs, curbs or slabs that will contact the surfacing system at the rate of 300 ft<sup>2</sup>/gal (7.5 m<sup>2</sup>/L).

D. Top Surface Installation:

1. Using a hand trowel, install top surface at a consistent density of 58 pounds, 9 ounces per cubic foot to a nominal thickness of 1/2".

2. Allow top surface to cure for a minimum of 48 hours for aromatic resin / 72 hours for aliphatic resin.

3. At the end of the minimum curing period, verify that the top surface is sufficiently dry and firm to allow foot traffic and use without damage to the surface.

4. Do not allow foot traffic or use of the surface until it is sufficiently cured.

**Specifier Note:** Specify provisions for protecting work after installation but prior to acceptance by the owner. Coordinate article below with Division 1 Execution Requirements Section.

### **3.05 PROTECTION**

A. Protect the installed playground surface from damage resulting from subsequent construction activity on the site.